

# OPERATING INSTRUCTIONS & SERVICE MANUAL

STEREO RECEIVER

## SANSUI SEVEN

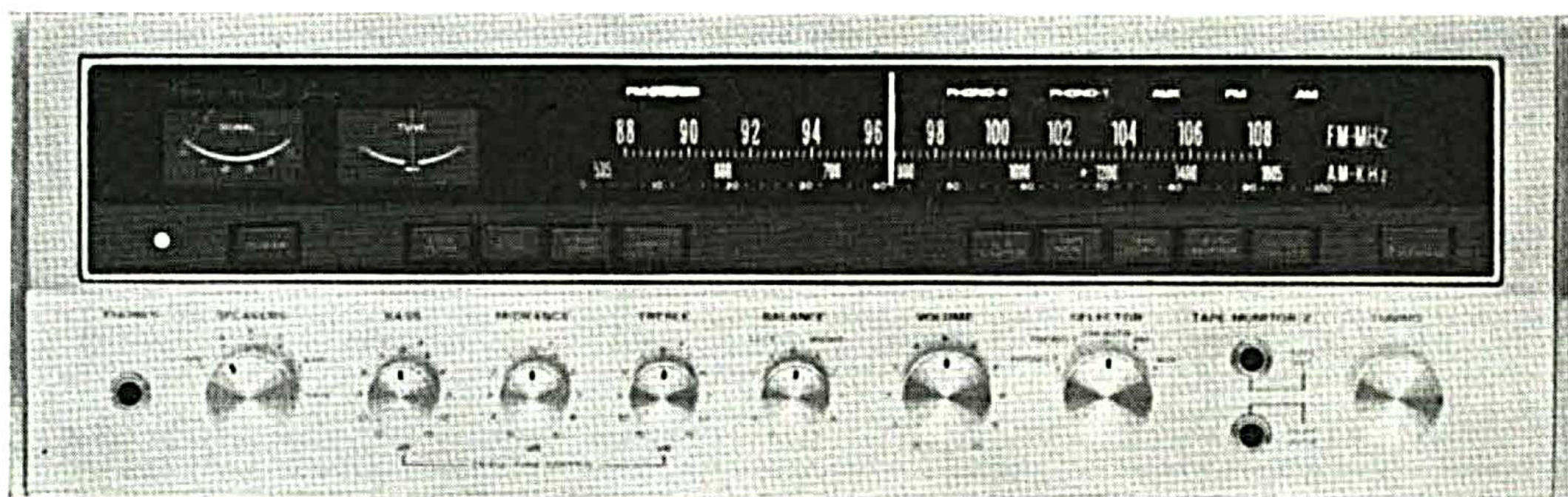

*Sansui*

SANSUI ELECTRIC CO., LTD.

Congratulations on joining the thousands of proud, satisfied owners of quality stereo components from Sansui, Japan's foremost audio-only specialist.

In many ways, the SEVEN is a culmination of our long experience and arduous research in the design and manufacture of quality audio-only equipment.

Its tuner section combines an FET-equipped super sensitive FM frontend and an IC-equipped FM IF amplifier which ensures outstanding FM selectivity and superb tone quality.

Its amplifier section is a 160-watt masterpiece designed, tested and proven to bring out every subtle shade of the original sound, regardless of the program source, free from distortion.

Over-all, the receiver is equipped with practically all the switches, controls, inputs and outputs that you would ever need to enjoy today's most advanced hi-fi sound reproduction.

This manual has been prepared to guide you in operating and caring for the receiver correctly, so that you will get the most out of its built-in high performance and exceptional versatility. May we suggest that you read it once carefully?

## **CONTENTS**

---

SWITCHES AND CONTROLS.....	3, 4, 5
CONNECTIONS .....	6, 7, 8
OPERATIONS .....	9
4-CHANNEL STEREO SYSTEM .....	10
NOISE REDUCTION SYSTEM .....	11
SIMPLE MAINTENANCE HINTS .....	12
SIMPLE MAINTENANCE HINTS/ACCESSORIES.....	13, 14
GENERAL TROUBLESHOOTING CHART .....	15, 16
SPECIFICATIONS .....	17
DISASSEMBLY PROCEDURE .....	18
TEST POINTS .....	19
SCHEMATIC DIAGRAM OF AMPLIFIER SECTION .....	20, 21
SCHEMATIC DIAGRAM OF TUNER SECTION.....	22, 23
ALIGNMENT .....	24, 25, 26
PRINTED CIRCUIT BOARDS AND PARTS LIST.....	27~39
OTHER PARTS AND THEIR LOCATION ON CHASSIS...	40~42



## SWITCHES AND CONTROLS

Explained on the right are the functions of the various switches and controls located on the front panel of your SEVEN. They are all designed and located to give you maximum control of the receiver with the greatest ease. Read the instructions once and you'll find every one of them is very easy to operate. The Operating Instructions Sheet, accompanying this booklet, carries the same information in a condensed form, for future quick references.

### Noise Filter Switches

**LOW:** Push to cut off low-frequency noise such as the rumbling of the turntable motor.  
**HIGH:** Push to cut off high-frequency noise such as the scratch noise of a worn record, tape hiss or the whistle noise in radio broadcasts. Leave the switches off at all other times.

### Power Switch

Push once to turn on the power supply for the entire receiver, once more to turn off.

### Power Indicator

### Headphone Jack

Accommodates a stereo headphone set for monitoring and private listening. When listening with headphones, turn the Speaker Selector to 'OFF.' The headphones used should be a dynamic type.

### Speaker Selector

**OFF:** To cut off the sound from the speaker systems when listening with headphones.  
**A:** To drive the speaker systems connected to the SYSTEM A terminals.  
**B:** To drive the ones connected to the SYSTEM B terminals.  
**C:** To drive the ones connected to the SYSTEM C terminals.  
**A+B:** To drive both A and B pairs of speaker systems.  
**A+C:** To drive both A and C pairs of speaker systems.

### Tuning and Signal Meters

The desired FM station is pinpointed when the Signal Meter pointer has swung as far to the right as possible and the Tuning Meter pointer is perfectly centered.  
An AM station, in contrast, is correctly tuned in when the Signal Meter pointer has swung as far to the right as it will go. You need not pay attention to the Tuning Meter.

### Loudness Switch

The human ear is such that an apparent 'drop-out' of the lows and highs occurs when you're listening at a low volume level. Pushing this switch compensates for this apparent loss and appropriately accents the lows and highs.

### FM Stereo Indicator

Lights when the receiver is tuned to an FM station broadcasting in stereo.

### Mono Switch

Push to hear in mono whatever program source you may have adjusted the receiver to reproduce.

### Function Indicators

#### Tape Monitor Switches

These switches control tape monitor circuits 1 and 2. See p. 9 of Operating Instructions for detailed instructions on the operation of tape decks.

#### 4-Channel Adaptor Switch

If you connect a 4-channel adaptor to the SEVEN and make other necessary connections, you will be able to upgrade this 2-channel stereo receiver to 4-channel stereo capabilities by pushing this switch (refer to p. 10 of Operating Instructions). Otherwise, be sure to keep it off.

#### FM Muting Release Switch

This switch, if not depressed, eliminates the interstation noise commonly heard when tuning on the FM band. It should be pushed to release the muting function when you are trying to tune in a weak FM station.

#### Tuning Control

Tune in the desired station by turning this control.

#### Tape Monitor-2 Jacks

A part of tape monitor circuit 2, these jacks connect a tape deck with phone plugs. The upper jack is for recording, and the lower one for playback. Connecting a tape deck here automatically disables the pin jack terminals and DIN connector socket of tape monitor circuit 2 on the receiver's rear panel.

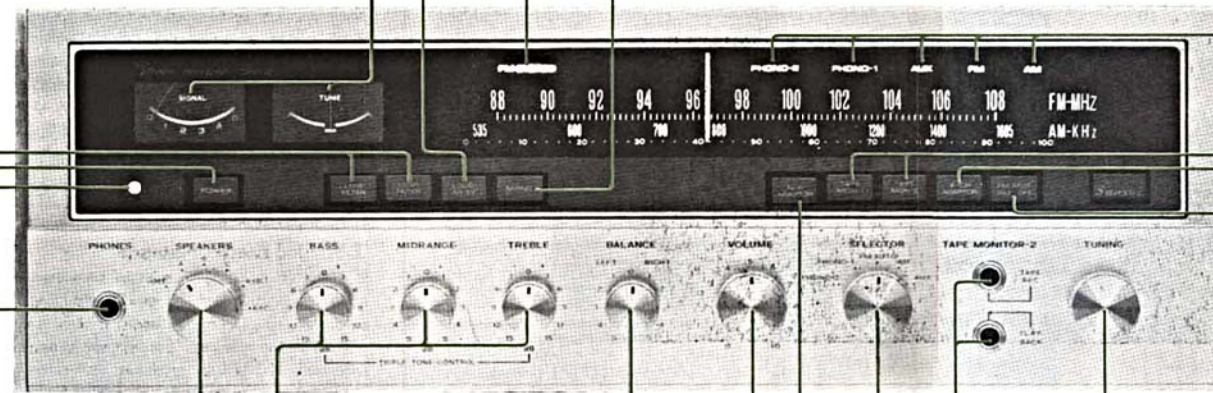

### Triple Tone Controls

**BASS:** Use to strengthen or weaken the receiver's low-end response. Turn it clockwise to emphasize the lows by 3dB per step.  
**MIDRANGE:** Use to strengthen or weaken the midrange response. Turn it clockwise to emphasize the midranges by 1dB per step.  
**TREBLE:** Use to strengthen or weaken the high-end response. Turn it clockwise to emphasize the highs by 3dB per step.

### Volume Control

Turn it clockwise to raise the volume.

### Balance Control

Use to balance the left and right channels.

### N.R. Adaptor Switch

If you connect a noise reduction adaptor to the SEVEN and want to record or reproduce on a tape deck via such adaptor, push this switch.

### Selector Control

Depending on what you wish to hear, turn to the appropriate position.  
**PHONO-2:** Selects a turntable connected to the PHONO 2 inputs.  
**PHONO-1:** Selects the one connected to the PHONO 1 inputs.  
**FM AUTO:** To hear FM broadcasts, whether stereo or mono.  
**AM:** To hear AM broadcasts.  
**AUX:** To hear whatever program source is connected to the AUX inputs.

# CONNECTIONS

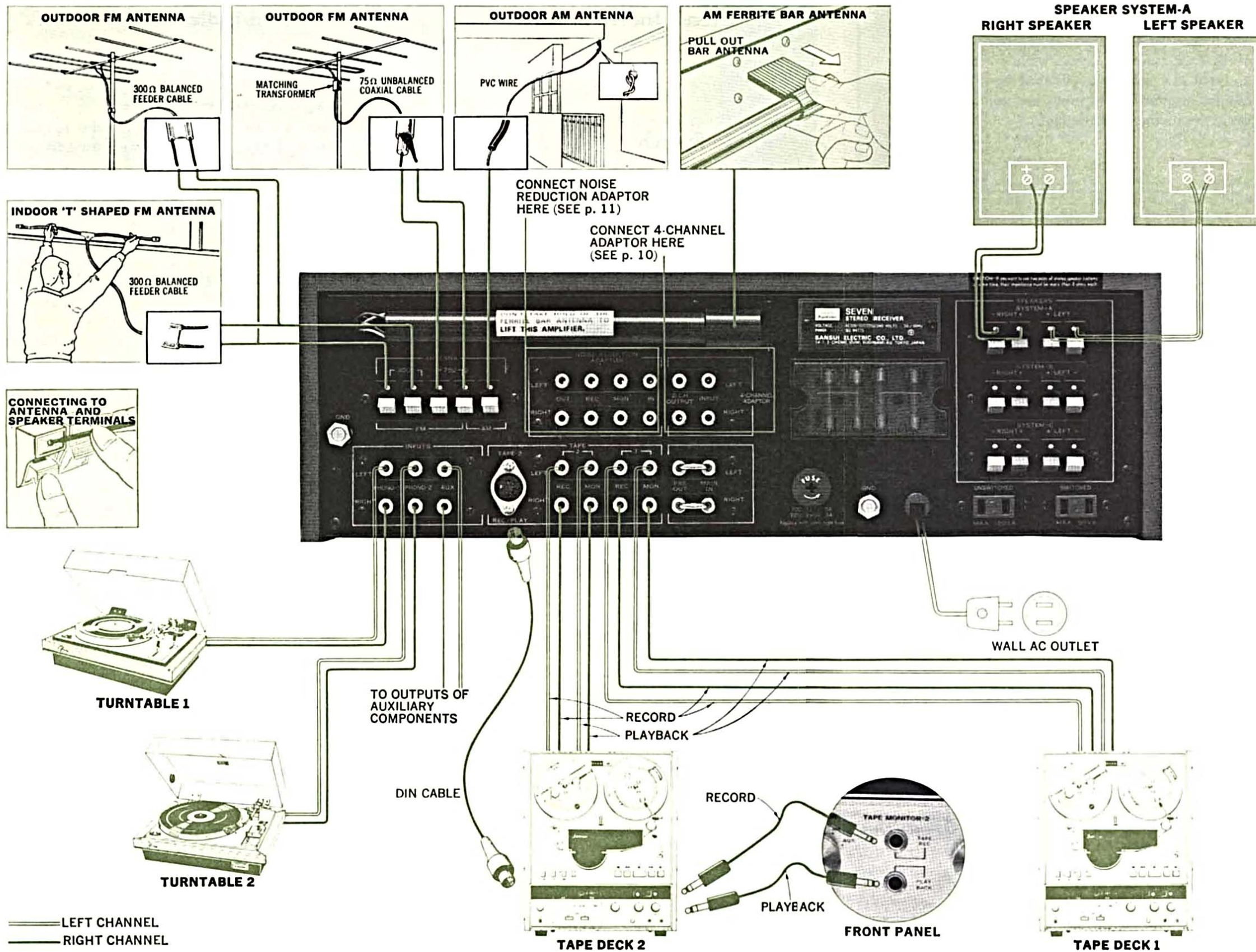

## Connecting Speaker Systems

The SEVEN connects up to three pairs of speaker systems. Any pair may be driven independently or a combination of two pairs may be driven, as selected by the Speaker Selector. Connect them to the receiver as instructed in the diagram on the left, taking care not to confuse the left and right channels and the plus and minus leads. Also, be very careful not to short-circuit the plus and minus leads.

## About the Speaker Impedance

Each speaker system connected to your SEVEN must possess an impedance of 4 to 16 ohms. Should you wish to drive two pairs of speaker systems simultaneously (by turning the Speaker Selector to the 'A+B' or 'A+C' position), each of them must have an impedance of 8 ohms or more.

## Connecting Antennas

### FM Antennas

#### T-Shaped Feeder Antenna

If you live in the proximity of broadcast stations, quality reception can be usually obtained by just setting up the T-shaped feeder cable antenna supplied with the receiver. Connect the antenna to the receiver's FM 300Ω terminals, set up the receiver for FM reception, stretch the antenna to a full T shape, and adjust its height and direction until the best reception is obtained.

#### Outdoor FM Antenna

Should the feeder cable antenna described above fail to give you a clear reception, try installing an outdoor FM antenna.

While many different types of antenna are commercially available, it is advisable to use one with at least 5 or 7 elements.

Using feeder cable, connect such antenna to the FM 300Ω antenna terminals of the receiver. Observe the following suggestions when connecting it:

1. As an antenna is directional, locate and orient the antenna in the place and direction which give you the best reception. Actually listen to your favorite FM station while you make the adjustments.

2. Be sure not to let the antenna touch electric cables and other objects.

3. Arrange the route of the feeder cable so as to keep it as short as possible.

4. Try to keep the antenna as far from streets as possible to prevent picking up the noise generated by automobiles.

If you should need long feeder cable to connect the antenna or where the automobile traffic is heavy, it is advisable to employ  $75\Omega$  coaxial cable. In this case, however, it is necessary to connect a matching transformer between the antenna and the coaxial cable to match their impedances. Be sure to connect the cable to the FM  $75\Omega$  terminals. (If the antenna itself has an impedance of  $75\Omega$ , no matching transformer is needed.)

## AM Antenna

### Ferrite Bar Antenna

The highly sensitive AM ferrite bar antenna, provided on the rear of the receiver, is usually sufficient to obtain a quality reception of AM stations. To use, simply pull it out as illustrated.

### Outdoor AM Antenna

Should the bar antenna fail to give you a clear reception, however, connect a piece of PVC wire supplied to the AM-A terminal on the receiver's rear panel and extend it outside a window or on the roof. Still better results can be obtained if you ground the receiver.

## Connecting Turntables

As the SEVEN is equipped with two phono input circuits, it is possible to employ two turntables or two tonearms with magnetic cartridges.

Connect the output cables of the turntable to the PHONO 1 or 2 input terminals. Be sure to keep the left and right channel cables in proper order.

### Note:

1. If you wish to use a moving-coil (MC) type cartridge, be sure to employ either a step-up transformer or separate head amplifier between the turntable and the SEVEN.

2. If you wish to use a ceramic or crystal type cartridge, connect the outputs of the turntable to the receiver's AUX input terminals.

## Connecting Tape Decks

The SEVEN is provided with two tape monitor circuits. One has pin jack terminals, while the other has pin jack terminals, a DIN connector socket and phone type jacks. If you are connecting only one tape deck, you are absolutely free to use any terminals which are most convenient to you. But if you are connecting two tape decks, be sure to connect one of them to the first tape monitor circuit, and the other to any terminals of the second tape monitor circuit.

### If Using Pin Jacks

If you are using the pin jack terminals to connect your tape deck, proceed as follows:

1. Connect a pair of shielded cables between the 'TAPE 1 (or 2) REC' pin jack terminals of the SEVEN and the recording input terminals of your tape deck.

2. Connect another pair of such cables between the receiver's 'TAPE 1 (or 2) MON' pin jack terminals and the tape deck's playback (monitor) output terminals.

**Note:** If you don't connect a 4-channel adaptor to the 4-CHANNEL ADAPTOR terminals on the rear panel, you may connect another tape deck to them. Use the 2-CH OUTPUT terminals as recording outputs, and INPUT terminals as playback inputs.

### If Using the DIN Socket

In the rather unlikely event that your tape deck is equipped only with a DIN connector socket, plug the DIN connector cable extending from it into the 5-pin DIN connector socket (marked TAPE-2 REC/PLAY) on the receiver's rear panel.

### If Using Phone Jacks

Should your tape deck be equipped with cables with phone type plugs, you may connect it to the phone jacks on the receiver's front panel. The tape deck's recording input plug should be inserted into the upper 'TAPE REC' jack, and its playback output plug into the lower 'PLAYBACK' jack.

Connecting a tape deck to the phone type jacks automatically disables the pin jack terminals and DIN connector socket of the second tape monitor circuit.

# OPERATIONS

## FM Reception

1. Set the Selector Control to 'FM AUTO.'
2. Tune in the desired FM station by turning the Tuning Control.  
It is correctly pinpointed when the Signal Meter pointer has swung as far to the right as possible and the Tuning Meter pointer is accurately centered.
3. Use the various other controls and switches to suit your personal preference.

## AM Reception

1. Set the Selector Control to 'AM.'
2. Tune in the desired AM station by turning the Tuning Knob until the Signal Meter pointer swings as far to the right as it will go near the frequency of that station. The Tuning Meter does not operate for AM.
3. Use the various other controls and switches to suit your personal preference.

## Playing Records

1. Set the Selector Control to 'PHONO-1' or 'PHONO-2,' depending on which input circuit you are using.
2. Start the turntable and play the record.
3. Use the various controls and switches to suit your personal preference.

## Recording and Playback on Tape Decks

### To Record into a Tape Deck

1. Set the receiver's Selector Control to the program source you want to record.
2. Start the tape deck in the recording mode.

### Signal Path Diagram of Tape Record/Playback Circuit

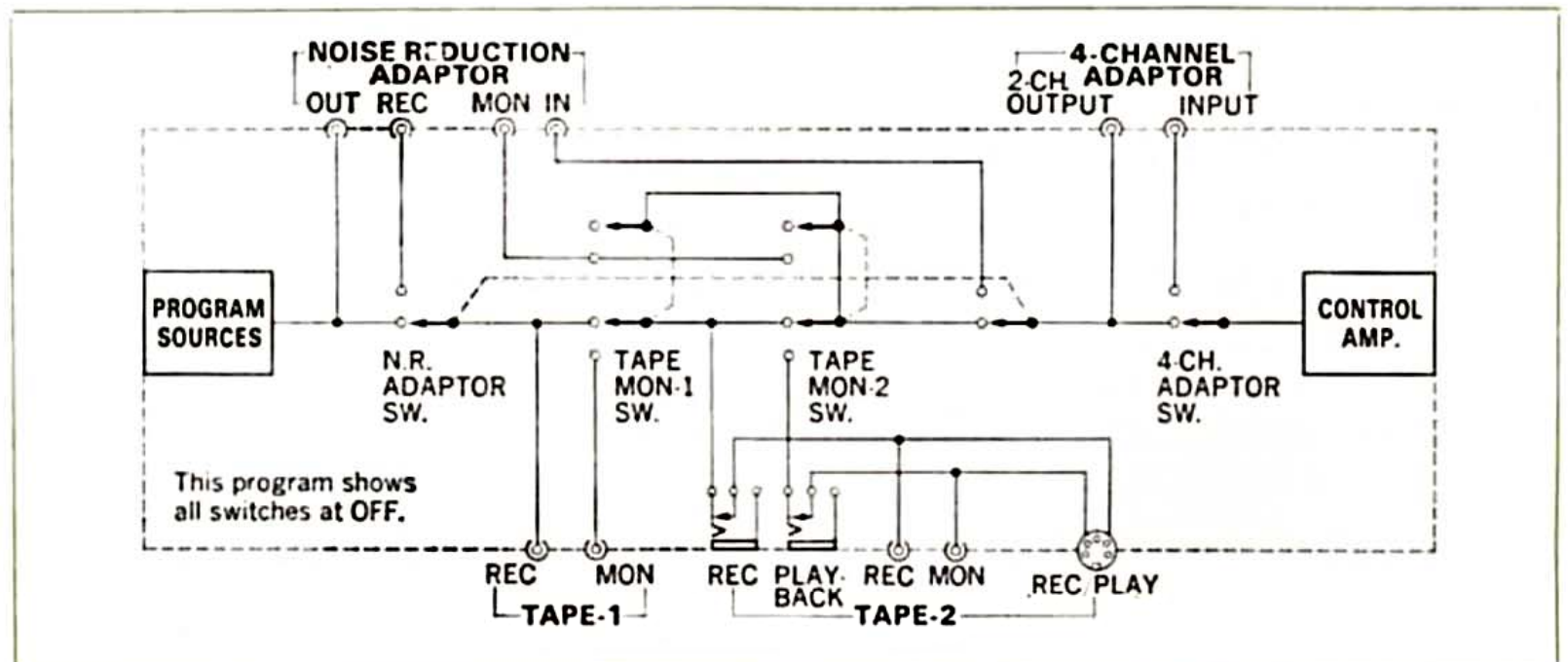

3. To monitor the sound being recorded, push the TAPE MON 1 or 2 Switch, depending on which of the two tape monitor circuits is accommodating the tape deck at the moment.

**Note:** Monitoring is possible only if the tape deck is equipped with separate heads for recording and playback.

### To Reproduce a Recorded Tape

1. Push the TAPE MON 1 or 2 Switch, depending on which of the two tape monitor circuits is accommodating the tape deck at the moment.
2. Start the tape deck in the playback mode.
3. Use the various controls and switches to suit your personal preference.

### Recording into Two Tape Decks Simultaneously

1. Set the Selector Control to the program source you want to record.
2. Start both tape decks in the recording mode.

### Recording from One Tape Deck into the Other

1. Push the TAPE MON 1 Switch.
  2. Start the tape deck connected to the second tape monitor circuit, in the recording mode.
  3. Now start the other tape deck (connected to the first tape monitor circuit) in the playback mode.
- Note:** The copying (dubbing) of a recorded tape, as described above, is only possible from a tape deck connected to the first tape monitor circuit to the one connected to the second tape monitor circuit.

# 4-CHANNEL STEREO SYSTEM

## 4-CHANNEL STEREO

The sound we daily hear is a mixture of the sounds that reach our ears straight from the sound source—be it a musical instrument, a jet, a man's mouth or what have you—and the 'indirect sounds' that arrive at our ears only after they are reflected off various surfaces, such as the walls, ceiling and so forth. Four-channel recordings are made using two microphones in the front of the concert hall and two in the rear (to simplify the explanation). The 'indirect sounds' with their complicated waveforms are mainly picked up by the two rear microphones and reproduced out of the two rear speakers in a 4-channel stereo set-up for greatly enhanced 'ambience' effects. The result is almost as if the original live performance were re-played right in your own room. This new approach can now be yours simply by adding certain equipment—mainly, a Sansui 4-channel rear amplifier and a second pair of speaker systems—to your 2-channel stereo system.

**SANSUI 4-CHANNEL REAR AMPLIFIER QS-500**



## Connecting a 4-Channel Adaptor

Connection of such a rear amplifier or 4-channel adaptor is easy. Just connect the 4-CHANNEL ADAPTOR 2-CH. OUTPUT terminals of your SEVEN with the input terminals of such rear amplifier or 4-channel adaptor, then connect its 4-CHANNEL ADAPTOR INPUT terminals with the output terminals of such unit.

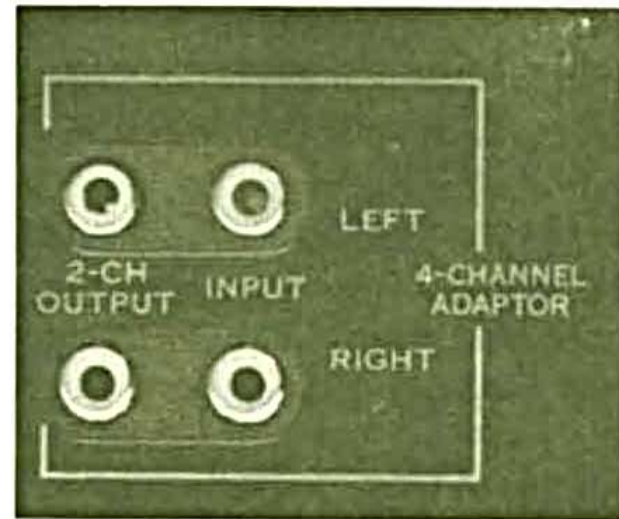

## Operation

To operate the rear amplifier or 4-channel adaptor so connected, push the 4CH ADAPTOR Switch on the receiver's front panel, and otherwise follow its manufacturer's instructions.

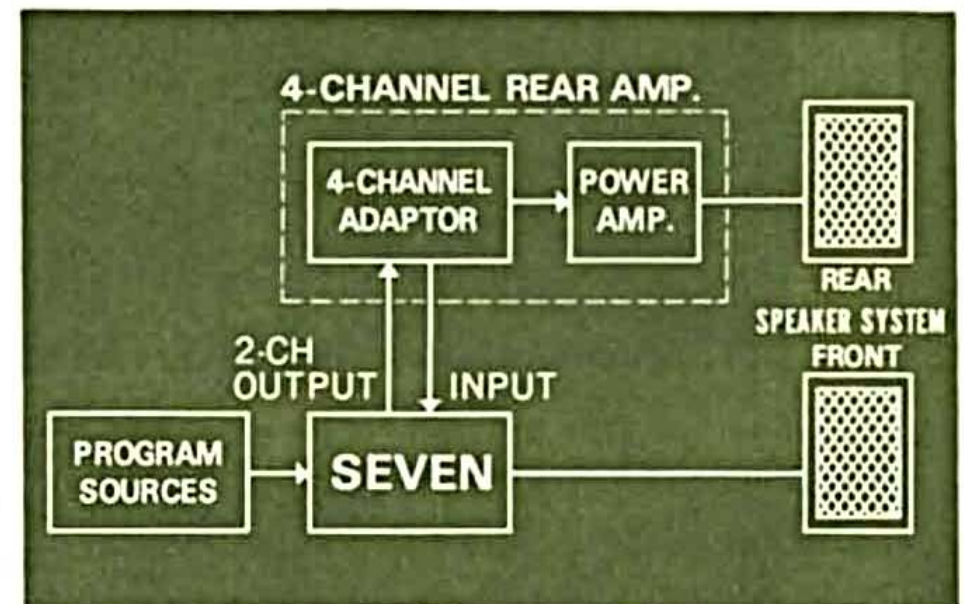



# NOISE REDUCTION SYSTEM

## About Noise Reduction Systems

Tape hiss is the single greatest annoyance to tape recording enthusiasts. To eliminate this noise, several noise reduction systems have been developed to date.

The latest innovation in this area is called the Dolby system, which reduces tape hiss most effectively without affecting the tone quality of the program source sound. It involves compressing low-level signals (where tape hiss is most annoying) during recording and then expanding them during playback in exactly the opposite manner.

The Dolby system often more than doubles the stereo listening enjoyment. To take maximum advantage of it, you only need couple a commercially available Dolby Noise Reduction Adaptor to your SEVEN.

## Connecting a N.R. Adaptor

Connect the Noise Reduction (N.R.) Adaptor to the NOISE REDUCTION ADAPTOR jacks on your SEVEN.

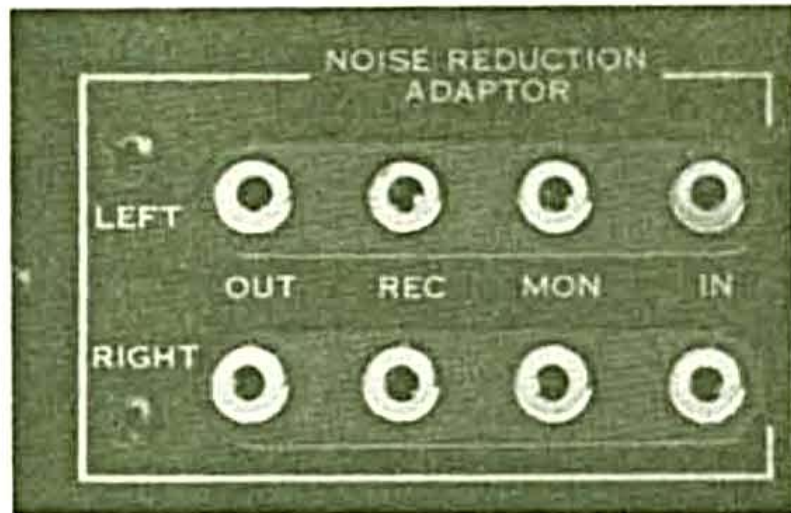

Such adaptor usually has four pairs of jacks—two for connecting a tape deck, and two more for connecting an amplifier (in this case the SEVEN).

However, as your SEVEN is equipped with provisions for connecting up to two tape decks, it is better to connect your tape deck(s) to the SEVEN (refer to 'Connecting Tape Decks' on page 8).

With your tape deck(s) so connected, regard the NOISE REDUCTION ADAPTOR-OUT, -IN, -REC and -MON jacks on your SEVEN's rear panel as equivalent to these terminals:

**OUT** ...Tape recording output jacks of an amplifier.

**IN** .....Tape playback input jacks of an amplifier.

**REC** ...Recording input jacks of a tape deck.

**MON**...Playback output jacks of a tape deck.

With this in mind, make these connections between the SEVEN and the n.r. adaptor:

SEVEN            N.R. Adaptor

**OUT** ...Input jacks of its recording circuit.

**REC** ...Output jacks of its recording circuit.

**MON**...Input jacks of its playback circuit.

**IN** .....Output jacks of its playback circuit.

## Operating a N.R. Adaptor

Operate the n.r. adaptor correctly according to the instructions supplied by its manufacturer. Then it is simply a matter of operating your tape deck correctly for recording and playback and pushing the N.R. ADAPTOR Switch on the SEVEN's front panel.

**Note:** When you are recording via a two-circuit type Dolby Noise Reduction Adaptor, changing its mode switch from record to playback by mistake is likely to cause a loud oscillating phenomenon. Be very careful to avoid such mistake.

# SIMPLE MAINTENANCE HINTS

## About the Place of Installation

The wooden cabinet of the SEVEN is designed so that any heat radiated inside will effectively escape through it. Proper care should therefore be taken of the dissipation of such heat if you wish to place something on top of the receiver or place it inside a closed box, etc. Above all, avoid placing it where it may be exposed to the direct sunlight.

## When Connecting a Turntable, etc.

To connect a turntable, tape deck and so forth, it is strongly recommended to use thick, shielded cables with minimal distributed capacitance and to keep them as short as possible.

To solder the pin plugs supplied as accessories onto such shielded cables, refer to the illustration below.

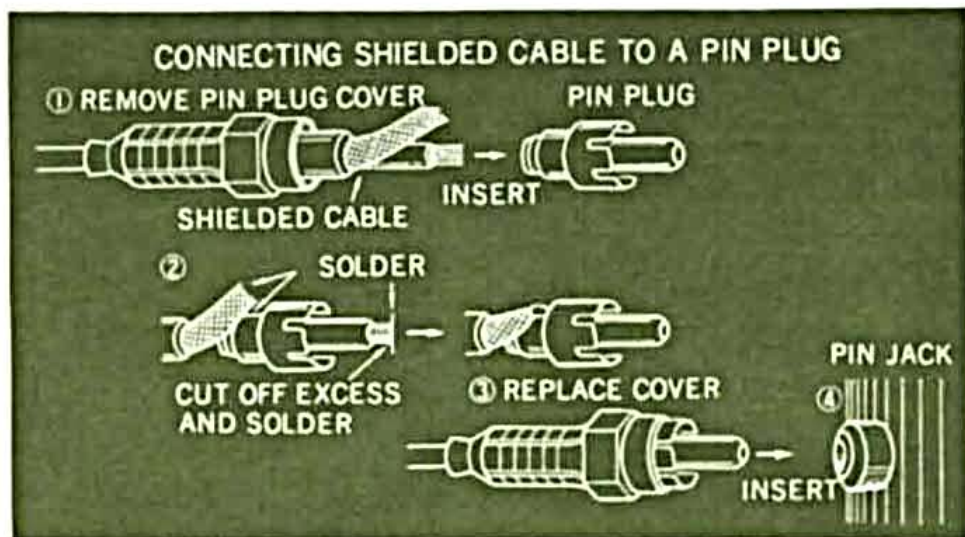

## Hum and Howling

Care must be taken never to place a turntable on or too near a speaker system, or the vibration of the speaker system is transmitted and causes howling. It is best to keep these components completely separate but if this is impossible, place a thick cushion between them.

Humming is a phenomenon caused by incomplete or incorrect turntable-receiver connections. Should this occur, check to see if all connections are completely made and if the connecting cables are sufficiently thick. Be sure to connect the grounding lead (or terminal) of the turntable to the GND terminal of the SEVEN. It may suppress the hum noise which may otherwise occur.

## PM Connectors

These are the U-shaped jumper connectors connecting the 'PRE OUT' (preamplifier output) jacks and the 'MAIN IN' (power amplifier input) jacks on the receiver's real panel, and can be easily pulled out. With these connectors unplugged, the preamplifier and power amplifier sections are separated and may be independently used. For example, a different power amplifier may be coupled to the 'PRE OUT' jacks.

Separating the preamplifier and power amplifier sections makes it possible to upgrade your stereo system further by adopting the 'electronic crossover system,' among other things.

### Note:

1. Be sure to leave the PM connectors firmly plugged in unless you want to separate the preamplifier and power amplifier sections for some purpose.
2. Turn off the Power Switch without failure before you plug in or out the PM connectors.

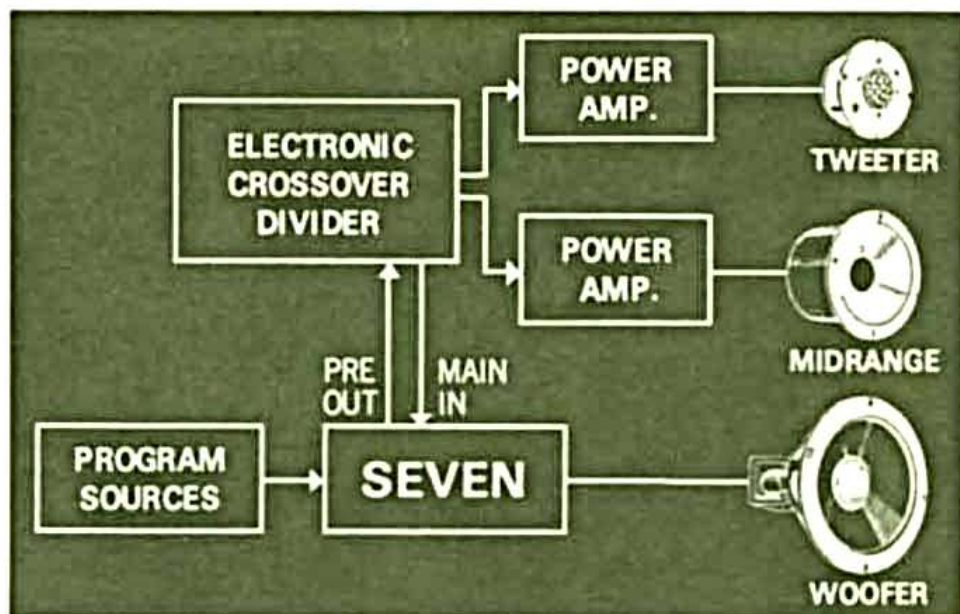
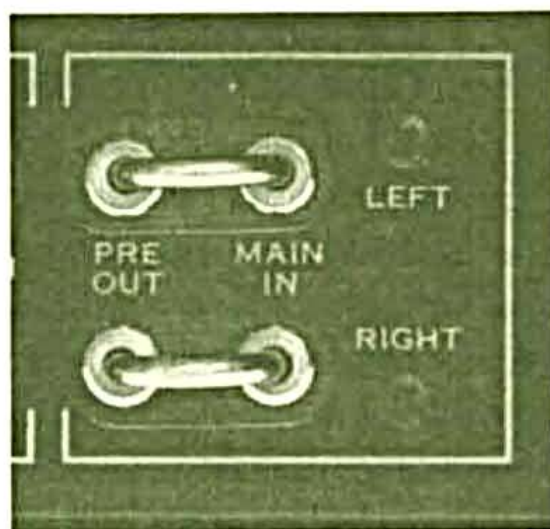

# SIMPLE MAINTENANCE HINTS / ACCESSORIES

## Quick-Acting Fuses

The SEVEN's power transistors are protected by four quick-acting fuses. They are located on the rear panel of the receiver, concealed inside a plastics cover.

When a Function Indicator is glowing, if no or distorted sound comes out of one or both of the speaker systems, examine their connections and your operating procedure once. If nothing is wrong with them, it is possible that one or more of the quick-acting fuses have blown. Should this happen, disconnect the power cord from the wall AC outlet immediately, then remove the metal cover by loosening the two screws securing it to the rear panel, and check the four quick-acting fuses. If you find any of them blown, discover and eliminate the cause of the blowout, and replace it with a new 4-ampere quick-acting fuse supplied. Probable causes of the blowout include excessively large input signals and a short-circuit at the speaker terminals.

## Should the Power Fuse Blow

If no Function Indicator should glow and the receiver simply remains dead even after you have turned on its Power Switch, it is possible that its power fuse has blown. If this happens, disconnect the power cord from the wall AC outlet at once and examine the power fuse on the receiver's rear panel. If you find it blown, replace it with a new glass-tubed fuse of the rated capacity (5-ampere for 100 to 127 volts, 3-ampere for 220 to 250 volts). Never use a fuse of a different capacity or a piece of wire, even as a stop-gap measure, or serious danger could result.

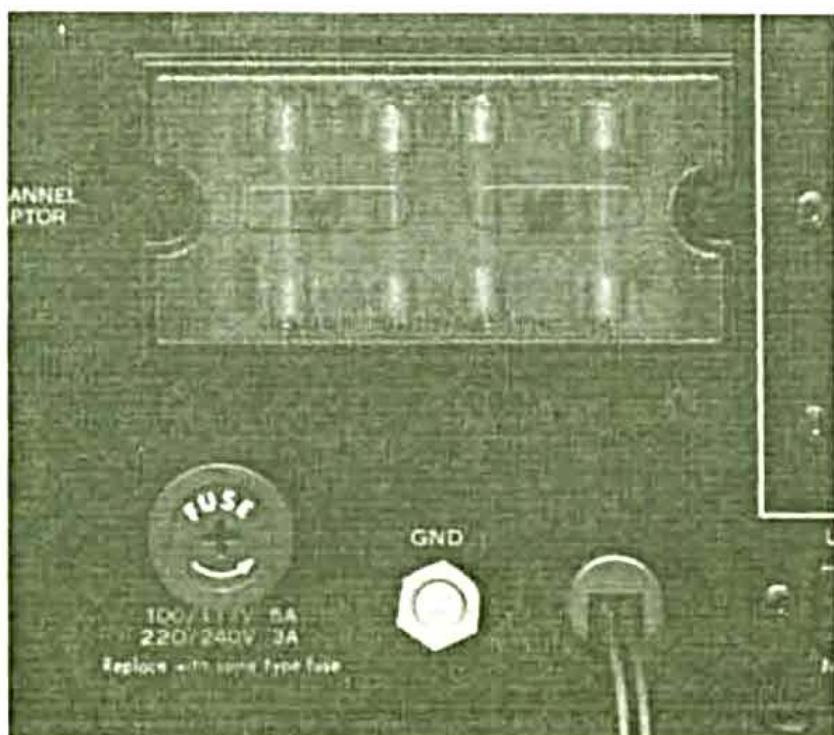

## Rear-Panel AC Outlets

Of the two AC outlets provided on the rear-panel, the one marked 'SWITCHED' is controlled by the front-panel Power Switch. The other, marked 'UNSWITCHED,' is always 'live' and independent of the Power Switch. The voltage delivered at these outlets is the same as the power supply voltage used.

The 'SWITCHED' and 'UNSWITCHED' outlets have a power capacity of 50 VA and 150 VA, respectively. Before you connect any appliance to them, be sure that it is adjusted for use at the same power supply voltage, and that its power consumption is not beyond these figures.

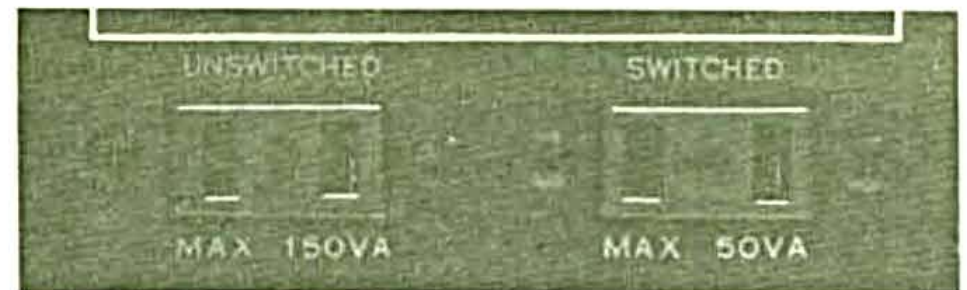

## Grounding

Any noise picked up by the connecting cables can be effectively grounded by connecting a piece of PVC (polyvinyl chloride) or enameled wire to the 'GND' terminal on the SEVEN's rear panel, attaching a small copper plate or carbon rod to the other end and burying it deep underground. The grounding leads of other equipment in your stereo system may be connected to the same terminal to ground the entire system at once.

If you have connected an external AM antenna to the receiver, it is advisable to ground it at the same time.

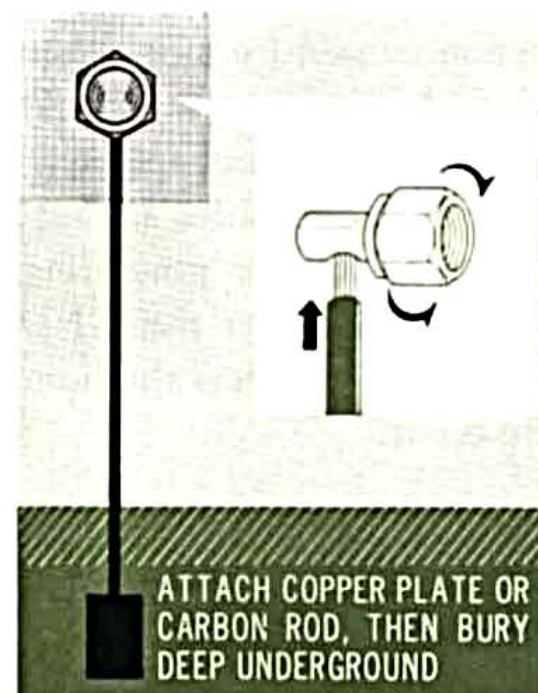

## Voltage Adjustment

In order to permit the use of your SEVEN in any part of the world, it is equipped with a Voltage Selector. It is set to the correct power supply voltage of your area prior to shipment, so there is no need to touch it. However, should you move after purchasing the unit and find the power supply voltage is different, simply reset the selector as follows:

1. Remove the two screws securing the name plate on the unit's rear panel, then remove the name plate.
2. Unplug the Voltage Selector once, and reset it so that the arrow mark on it faces the correct voltage indication. Change the power fuse also whenever the power supply voltage has changed. For 100/117 volt operation, use a 5-ampere glass-tubed fuse. For 220/240 volt operation, use a 3-ampere one.
3. Where the power supply voltage considerably fluctuates, the Voltage Selector may be reset to avoid unpleasant side effects of such fluctuation. Reset it to the voltage immediately higher than the peak of the fluctuation.

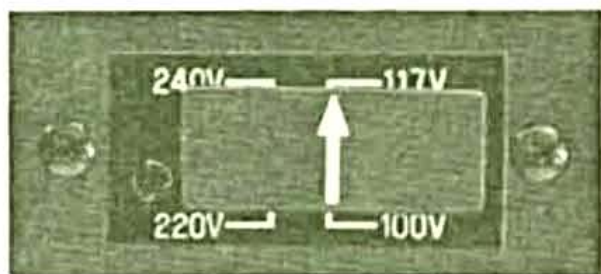

## About Servicing

If anything should ever go wrong with your SEVEN, or if you have any question about it, please contact the Sansui dealer from whom you purchased it or your nearest Authorized Sansui Service Station.

## ACCESSORIES

1. FM Antenna.....	1
2. AM Antenna.....	1
3. Pin Plugs .....	2
4. Butterfly Bolts .....	2
5. Washers .....	2
6. Polishing Cloth .....	1
7. Quick-acting Fuses (4A) .....	2
8. Operating Instructions and Service Manual .....	1
9. Operating Instructions Sheet .....	1

# GENERAL TROUBLESHOOTING CHART

If the receiver is otherwise operating satisfactory, the more common causes of trouble may generally be attributed to the following:

1. Incorrect connections or loose terminal contacts. Check the speakers, turntable, tape deck, antenna and power cord.
2. Improper operation. Before operating any audio com-

ponent, be sure to read its manufacture's instructions.

3. Improper location of audio components. The proper positioning of components, such as speakers and turntable, is essential to maximum stereo enjoyment.

4. Defective audio components.

The following are some other common causes of malfunction and what to do about them.

PROGRAM	SYMPTOM	PROBABLE CAUSE	WHAT TO DO
AM, FM or MPX reception.	A. Constant or intermittent noise heard at times or in certain area.	<ul style="list-style-type: none"> <li>* Discharge or oscillation caused by electrical appliances, such as fluorescent lamp, TV set, D.C. motor rectifier or oscillator.</li> <li>* Natural phenomena, such as atmospheric, static or thunderbolts.</li> <li>* Insufficient antenna input due to ferroconcrete wall or long distance from station.</li> </ul>	<ul style="list-style-type: none"> <li>* Attach noise limiter to electrical appliance producing noise, or attach it to receiver's power source.</li> <li>* Install outdoor antenna and ground receiver to raise SN ratio.</li> <li>* Reverse power cord plug/receptacle connections.</li> <li>* If noise occurs at certain frequency, attach wave trap to input.</li> <li>* Keep receiver at proper distance from other electrical appliances.</li> </ul>
AM reception.	A. Noise heard at particular time of day, in certain area or over part of dial.	<ul style="list-style-type: none"> <li>* Peculiar to AM broadcasts.</li> </ul>	<ul style="list-style-type: none"> <li>* Install antenna for maximum antenna efficiency. See CONNECTIONS in operating instructions booklet.</li> <li>* In some cases, noise can be eliminated by grounding receiver or reversing power cord plug/receptacle connections.</li> </ul>
	B. High-frequency noise.	<ul style="list-style-type: none"> <li>* Adjacent-channel interference or beat interference.</li> <li>* TV set too close to stereo system.</li> </ul>	<ul style="list-style-type: none"> <li>* Such noise cannot be completely eliminated by receiver, but it is advisable to turn Treble control counterclockwise, or turn on High Filter.</li> <li>* Keep TV set at proper distance from stereo system.</li> </ul>
FM reception.	A. Noisy.	<ul style="list-style-type: none"> <li>* Poor noise limiter effect or too low SN ratio due to insufficient antenna input.</li> </ul> <p>Note: FM reception is affected considerably by transmission conditions of station, such as power and antenna efficiency. As a result, you may receive one station quite well while receiving another station poorly.</p>	<ul style="list-style-type: none"> <li>* Install antenna (supplied) for maximum signal strength.</li> <li>* If this does not prove effective, use exclusive FM outdoor antenna. If using TV antenna for both TV and FM with divider, make sure TV reception is not affected.</li> <li>* Excessively long lead-in wire of antenna may cause noise.</li> </ul>
	B. A series of pops.	<ul style="list-style-type: none"> <li>* Ignition noise caused by starting of nearby automobile engine.</li> </ul>	<ul style="list-style-type: none"> <li>* Install antenna and its lead-in wire at proper distance from street or increase antenna input as described before.</li> </ul>
	C. Tuning noise between stations.	<ul style="list-style-type: none"> <li>* Results from nature of FM reception.</li> <li>* FM Muting Release switch depressed.</li> </ul>	<ul style="list-style-type: none"> <li>* Release FM Muting Release switch.</li> <li>* Ditto.</li> </ul>

PROGRAM	SYMPTOM	PROBABLE CAUSE	WHAT TO DO
FM-MPX reception.	A. Noise heard during FM-MPX reception but inaudible during FM mono reception.	* Weaker signal because service area of FM-MPX broadcast is only half that of FM mono broadcast.	* Orient antenna for maximum antenna input. * Switch on High Filter and/or turn Treble control counterclockwise.
	B. Channel separation deteriorates during reception.	* Excess heat.	* Circulation of room air is important to receiver. Be sure that receiver is well ventilated.
	C. Stereo indicator blinks on and off.	* Interference.	* Indicator is not faulty, adjust VR <sub>402</sub> .
Record playing or tape playback.	A. Hum or howling.	* Turntable placed directly on speaker. * Wire other than shielded cable used. * Loose terminal contact. * Shielded cable too close to power cord, fluorescent lamp or other appliances. * Nearby amateur radio station or TV transmission antenna.	* Place cushion between turntable and speaker cabinet or place them away from each other. * Connecting shielded cables should be as short as possible. * Turn on Low Filter or turn Bass control counterclockwise. * Consult nearest Radio Regulatory Bureau.
	B. Surface noise.	* Worn or old record. * Worn phono stylus. * Phono stylus dusty. * Improper stylus pressure.	* Recondition playback head of tape deck or replace turntable stylus. * Turn Treble control counterclockwise * Turn High Filter on.

# SPECIFICATIONS

## AUDIO SECTION

### POWER OUTPUT

IHF MUSIC POWER: 160W 4Ω at 1,000Hz  
120W 8Ω at 1,000Hz

CONTINUOUS RMS POWER (each channel driven)  
60/60W 4Ω at 1,000Hz  
47/47W 8Ω at 1,000Hz

CONTINUOUS RMS POWER (both channels driven)  
41 + 41W 8Ω at 1,000Hz

CONTINUOUS RMS POWER (both channels driven,  
20 to 20,000Hz): 36 + 36W 8Ω load

### TOTAL HARMONIC DISTORTION

POWER AMPLIFIER ONLY:  
less than 0.3% at rated output

PRE-AMP ONLY (PHONO to Pre output):  
less than 0.2% at rated output

PRE-AMP ONLY (AUX to Pre output):  
less than 0.1% at rated output

OVER-ALL (AUX to Power output):  
less than 0.3% rated output

INTERMODULATION DISTORTION (70Hz: 7,000Hz =  
4:1 SMPTE METHOD)

POWER AMPLIFIER ONLY:  
less than 0.3% at rated output

OVER-ALL (AUX to Power output):  
less than 0.3% at rated output

POWER BANDWIDTH (IHF): 10 to 50,000Hz at 8Ω load

FREQUENCY RESPONSE: at 1 watt  
OVER-ALL (AUX to Power output):  
15 to 40,000Hz + 1dB, - 1.5dB

POWER AMPLIFIER ONLY:  
15 to 40,000Hz + 1dB, - 1.0dB

DEVIATION FROM RIAA: + 1dB, - 1dB (30 to 15,000Hz)

LOAD IMPEDANCE: 4 to 16Ω

DAMPING FACTOR: approximately 50 at 8Ω load

CHANNEL SEPARATION (at rated output 1,000Hz)

POWER AMPLIFIER ONLY: 60dB

OVER-ALL (from PHONO): 50dB

OVER-ALL (IHF) 50dB

HUM AND NOISE (IHF)

OVER-ALL (from PHONO): 70dB

OVER-ALL (from AUX): 80dB

POWER AMPLIFIER ONLY: 90dB

INPUT SENSITIVITY AND IMPEDANCE (at rated  
output 1,000Hz)

PHONO: 2.5mV (50kΩ)

MAX. INPUT CAPACITY:  
100mV at 0.5% distortion

AUX: 150mV (50kΩ)

TAPE MONITOR: 150mV (50kΩ)

N.R. ADAPTOR: 150mV (50kΩ)

4-CH ADAPTOR: 150mV (50kΩ)

POWER AMPLIFIER INPUT: 800mV (50kΩ)

### OUTPUT LEVEL:

TEPE MONITOR (DIN): 30mV

PHONE TYPE, PIN: 150mV

PREAMPLIFIER: 800mV

MAX: 4,000mV (at 0.5%  
distortion)

### TONE CONTROLS

BASS: + 15dB, - 15dB at 20Hz (3dB step)

MIDANGE: + 5dB, - 5dB at 15,000Hz (1dB step)

TREBLE: + 15dB, - 15dB at 20,000Hz (3dB step)

### FILTERS

LOW: - 10dB at 50Hz (12dB/oct.)

HIGH: - 10dB at 10,000Hz (12dB/oct.)

LOUDNESS: + 10dB at 50Hz, + 8dB at  
10,000Hz

## TUNER SECTION

### FM:

TUNING RANGE: 88 to 108MHz

SENSITIVITY (IHF): 1.8μV

SIGNAL TO NOISE RATIO: better than 63dB

IMAGE FREQUENCY REJECTION:  
better than 80dB at 98MHz

SPURIOUS RESPONSE REJECTION:  
better than 100dB

SELECTIVITY: better than 60dB

IF REJECTION: better than 100dB

CAPTURE RATIO: better than 1.5dB

SPURIOUS RADIATION: less than 34dB

TOTAL HARMONIC DISTORTION  
MONO: less than 0.3%  
STEREO: less than 0.5%

STEREO SEPARATION: better than 40dB at 400Hz

FREQUENCY RESPONSE: 30 to 12,000Hz + 1dB, - 2dB

ANTENNA INPUT IMPEDANCE:  
300Ω balanced, 75Ω unbalanced

### AM:

TUNING RANGE: 535 to 1,605kHz

SENSITIVITY (Bar Antenna): 46dB/m

SELECTIVITY (± 10kHz): better than 30dB

IMAGE FREQUENCY REJECTION:  
better than 100dB/m at 1,000kHz

IF REJECTION: better than 100dB/m at 1,000kHz

SEMICONDUCTORS:  
74 Transistors, 42 Diodes, 4 Zener Diodes, 1 IC

### POWER REQUIREMENTS

POWER VOLTAGE: 100, 117, 220, 240V 50/60Hz

POWER CONSUMPTION: Max. 310VA 250W

Rated 130VA 102W

DIMENSIONS: 440mm, 17-3/8"W.

140mm, 5-9/16"H.

328mm, 13"D.

WEIGHT: 14.3kg (31.5 lbs.)

# DIASSEMBLY PROCEDURE

## REMOVING FRONT PANEL, WOOD BONNET AND BOTTOM BOARD

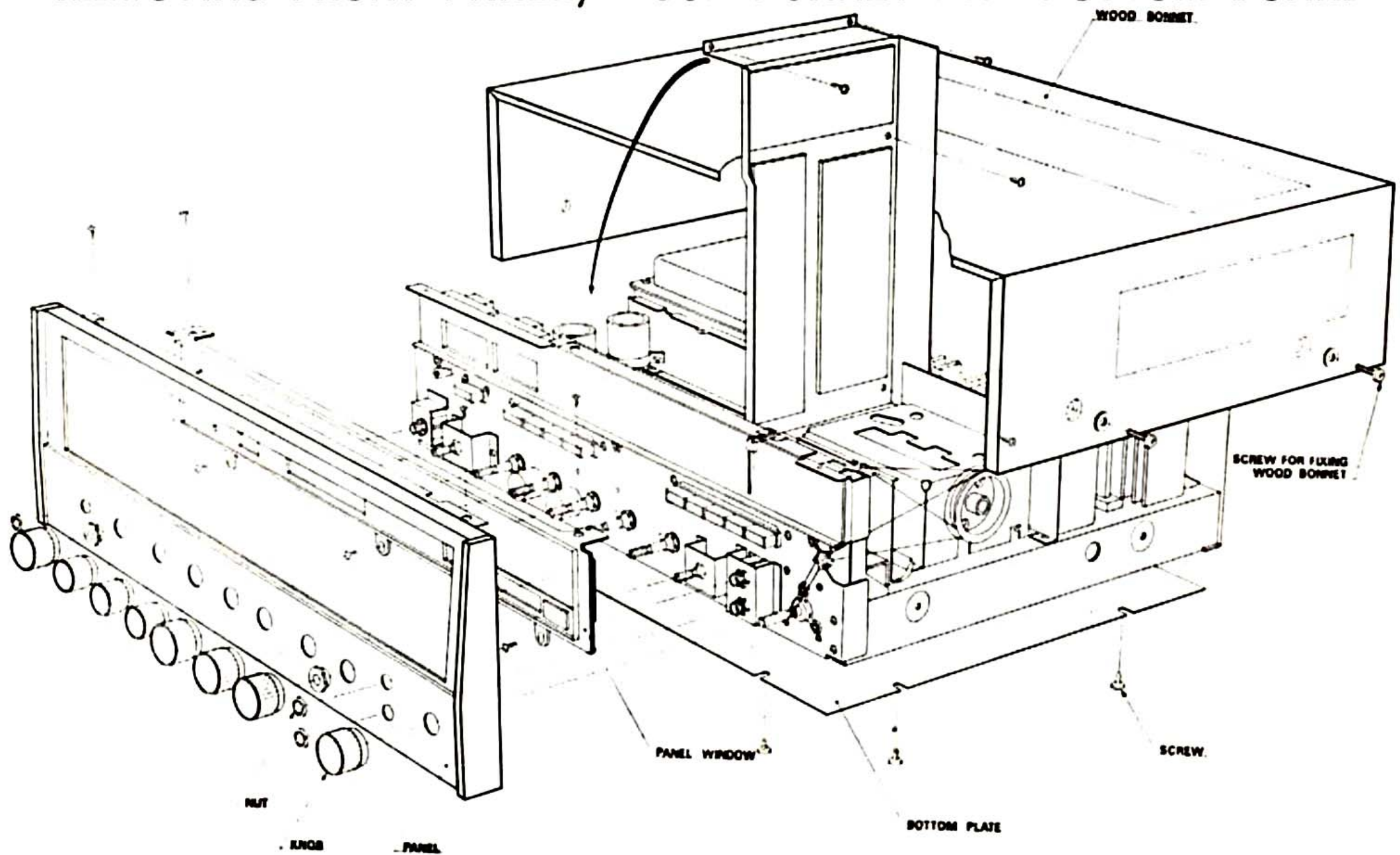

## DIAL MECHANISM

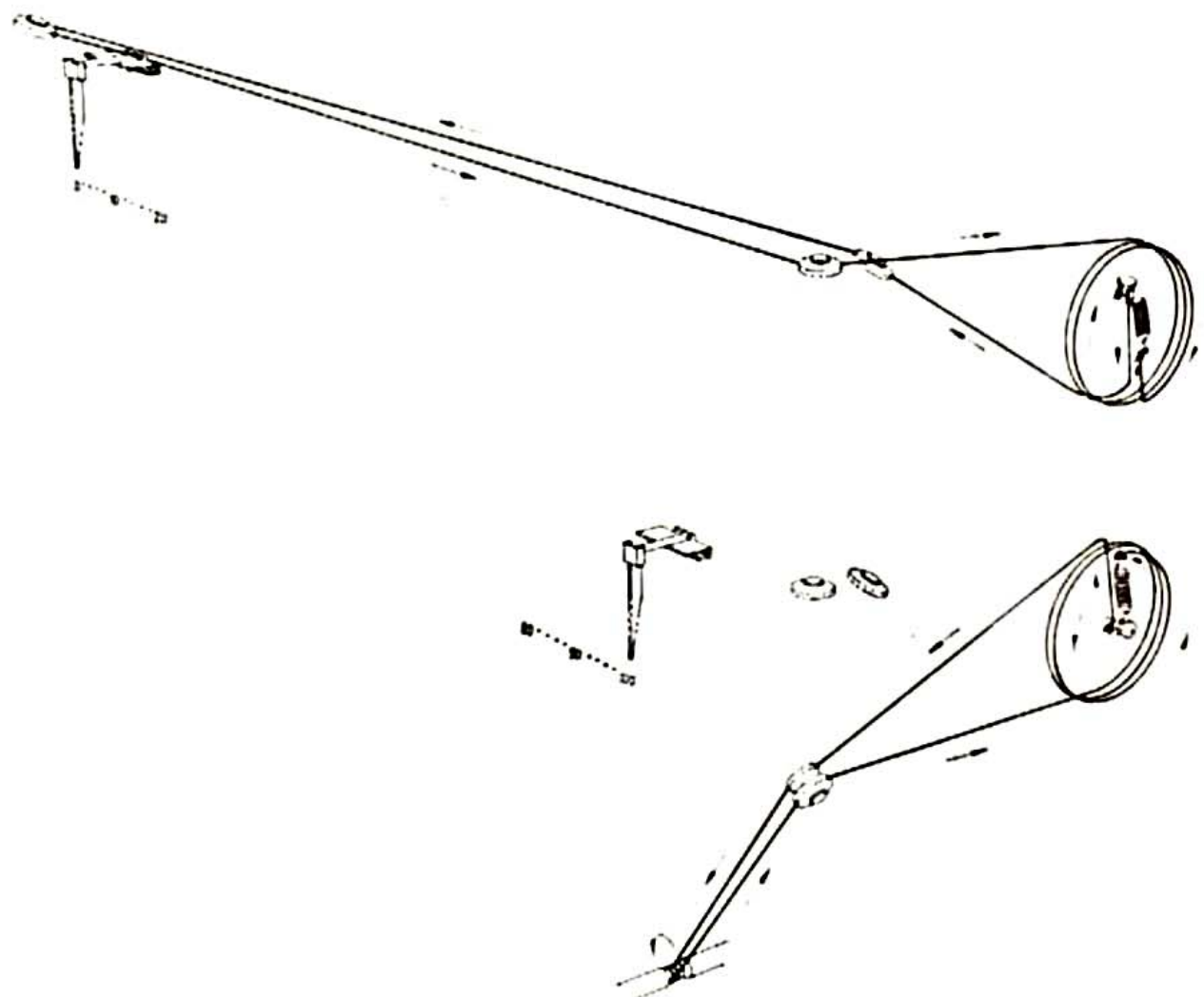



# TEST POINTS

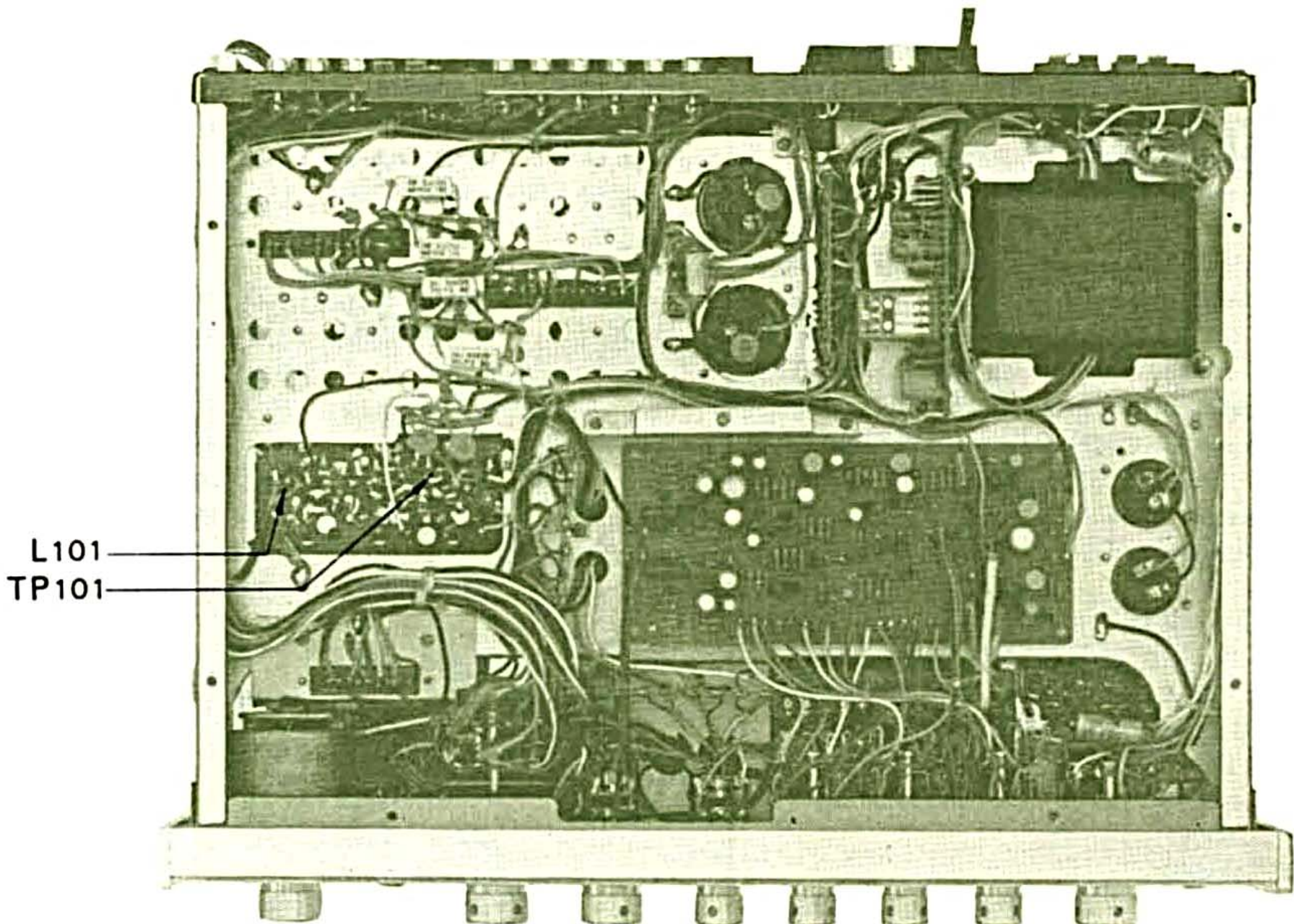
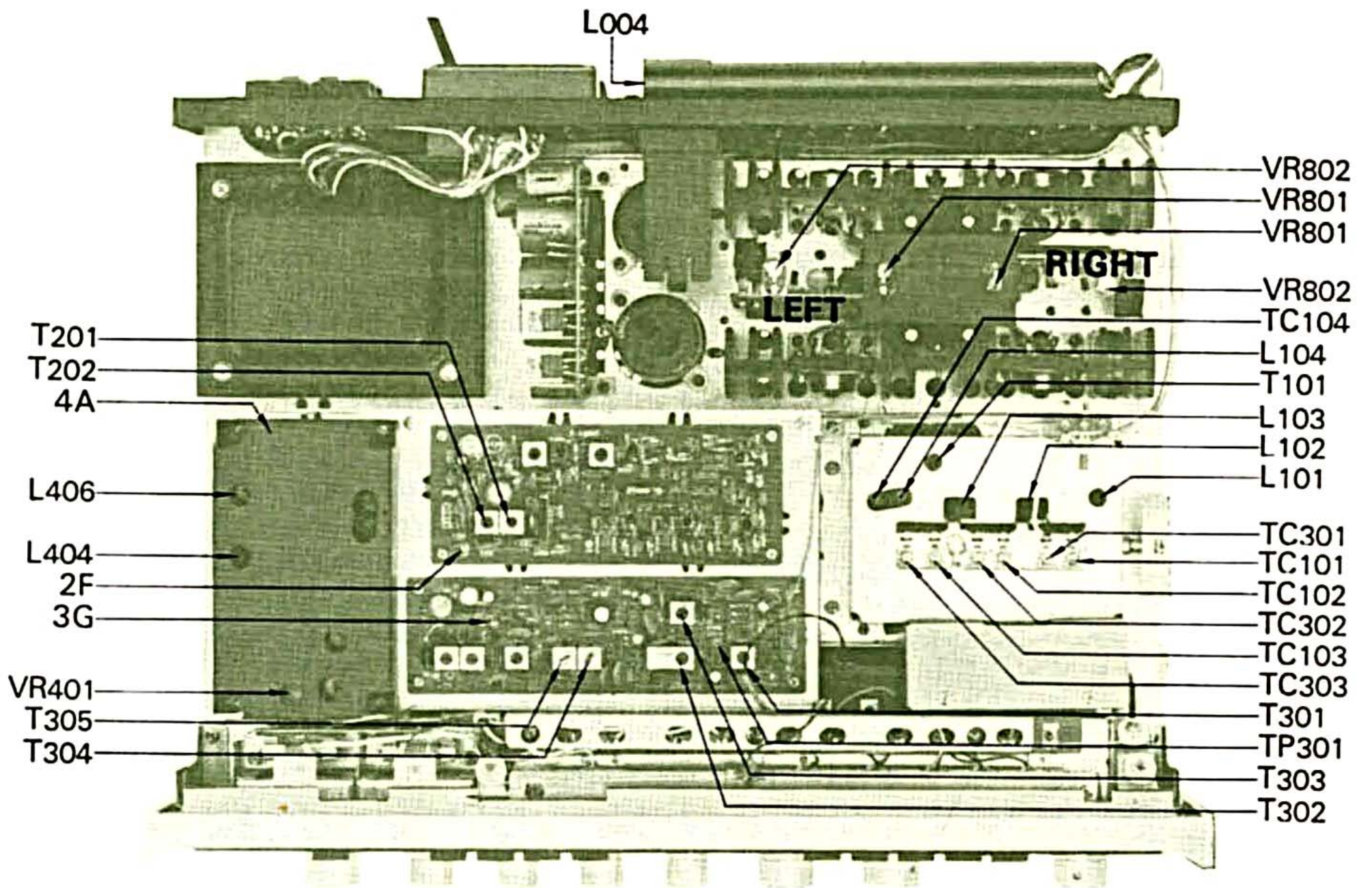

# SCHEMATIC DIAGRAM OF AMPLIFIER SECTION

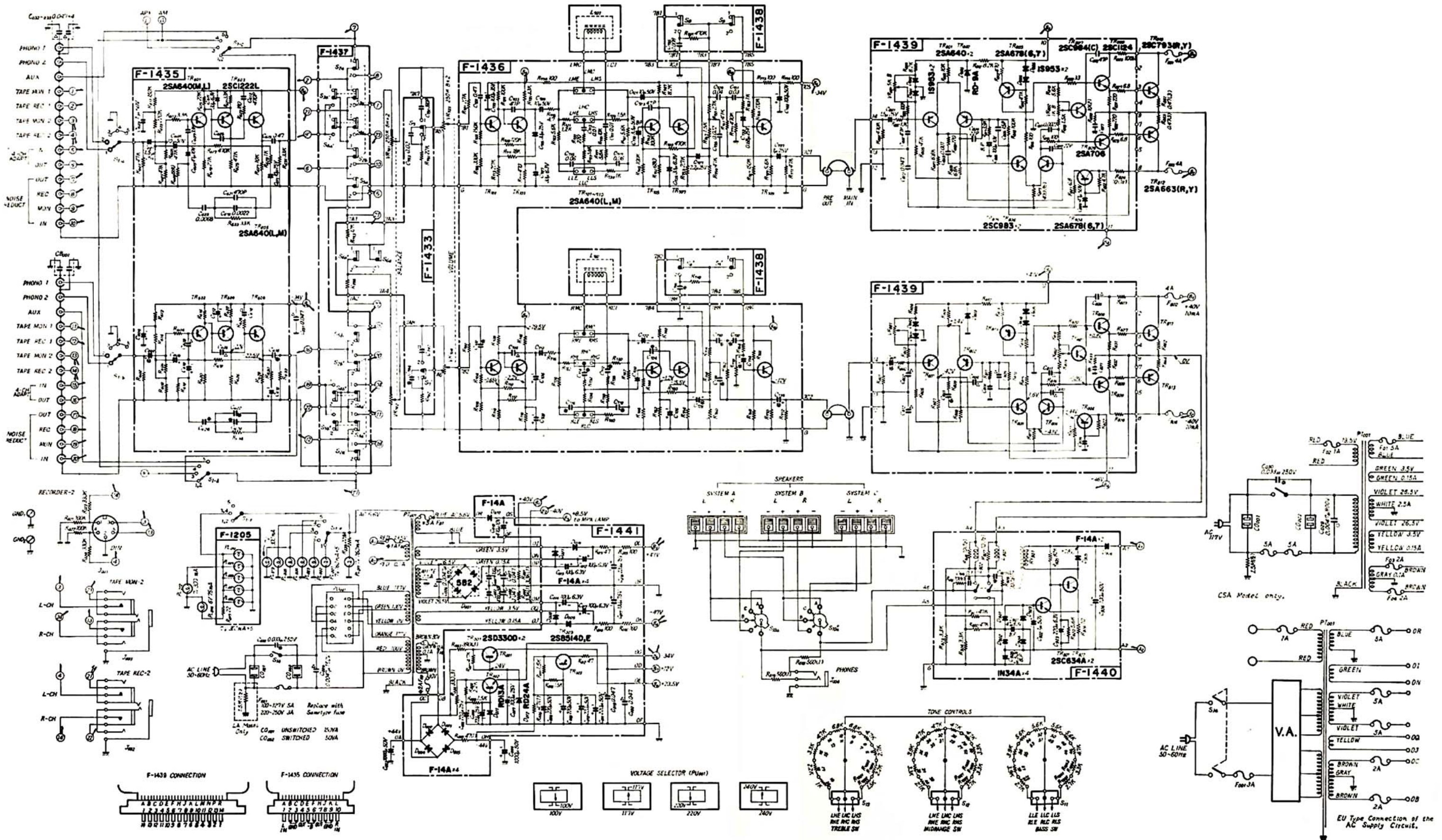

# SCHEMATIC DIAGRAM OF TUNER SECTION

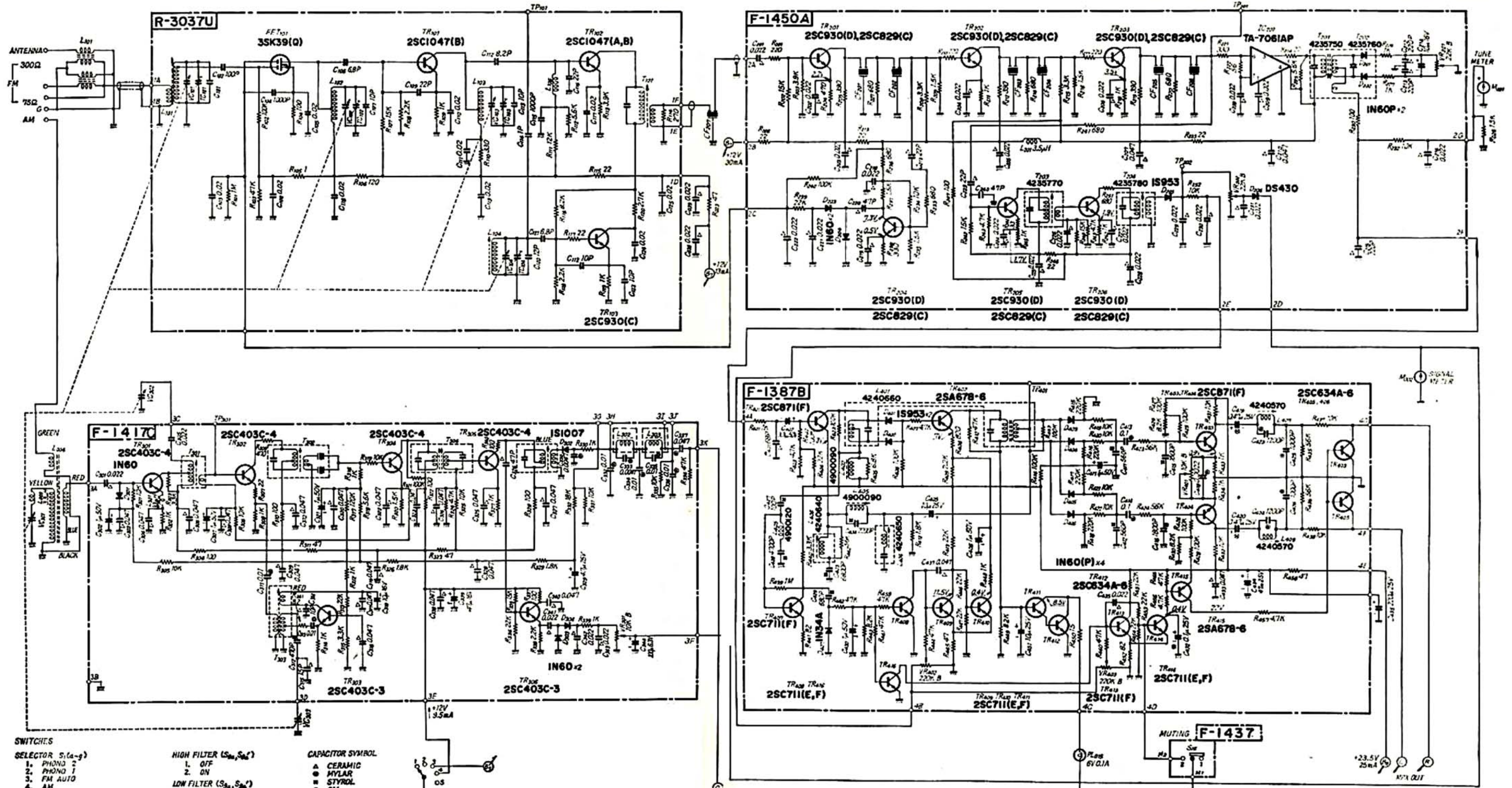

- SWITCHES**
- SELECTOR  $S_1(S_{1a}-g)$**
1. PHONO 2
  2. PHONO 1
  3. FM AUTO
  4. AM
  5. AUX
- NOISE REDUCTION ADAPTOR  $(S_{2a}, S_{2b}, S_{2c}, S_{2d})$**
1. OFF
  2. ON
- TAPE MONITOR 1  $(S_{3a}, S_{3b}, S_{3c}, S_{3d})$**
1. OFF
  2. ON
- TAPE MONITOR 2  $(S_{4a}, S_{4b}, S_{4c}, S_{4d})$**
1. OFF
  2. ON
- 4CH ADAPTOR  $(S_{5a}, S_{5b})$**
1. OFF
  2. ON
- MONO  $(S_{6a}, S_{6b})$**
1. STEREO
  2. MONO
- LOUDNESS  $(S_{7a}, S_{7b})$**
1. OFF
  2. ON
- HIGH FILTER  $(S_{8a}, S_{8b})$**
1. OFF
  2. ON
- LOW FILTER  $(S_{9a}, S_{9b})$**
1. OFF
  2. ON
- SPEAKERS  $(S_{10a}, S_{10b})$**
1. OFF
  2. A
  3. B
  4. C
  5. A+B
  6. A+C
- BASS SW  $(S_{11a}, S_{11b})$**
1. OFF
  2. ON
- MIDRANGE SW  $(S_{12a}, S_{12b})$**
1. OFF
  2. ON
- TREBLE SW  $(S_{13a}, S_{13b})$**
1. OFF
  2. ON
- POWER SW  $(S_{14})$**
1. OFF
  2. ON
- FM MUTING  $(S_{15})$**
1. ON
  2. OFF
- CAPACITOR SYMBOL**
- ▲ CERAMIC
  - MYLAR
  - STYROL
  - OIL
  - ◻ TANTALUM
  - ◼ NICA
- ALL RESISTORS ARE 1/4WATT UNLESS OTHER WISE NOTED**

# ALIGNMENT

## OUTPUT BALANCE ALIGNMENT OF POWER AMPLIFIER

STEP	CONNECT/ADJUST	REMARKS
1.	Connect 8-ohm (or 16-ohm) resistor (minimum rating of 50 watts) to SYSTEM-A left-channel speaker terminal.	
2.	Connect voltmeter to same speaker terminal.	Use voltmeter with 0.1-1V range.
3.	Set Speaker Selector to SYSTEM-A position.	
4.	Adjust VR <sub>801</sub> (left channel) so that voltage will be kept within $0 \pm 50\text{mV}$ .	
5.	For right channel, repeat above procedure, but adjust VR <sub>801</sub> (right channel) in step 4.	

## CURRENT ALIGNMENT OF POWER AMPLIFIER

STEP	CONNECT/ADJUST	REMARKS
1.	Remove F <sub>801</sub> and F <sub>802</sub> .	Refer to "About the Quick-Acting Fuses" (page 13).
2.	Turn VR <sub>802</sub> (left and right channels) fully counterclockwise.	
3.	Tun on receiver.	
4.	Connect ammeter (tester) where F <sub>801</sub> was (refer to illustration below).	Be sure power is turned on before connecting ammeter. Set ammeter to its 30~100mA range.
5.	Turn VR <sub>802</sub> (left channel) slowly clockwise until ammeter shows $15 \pm 3\text{mA}$ .	
6.	Turn off power, then replace F <sub>801</sub> .	
7.	Turn on power again.	
8.	Now, connect ammeter where F <sub>802</sub> was (refer to illustration below).	
9.	Turn VR <sub>802</sub> (right channel) slowly clockwise until ammeter shows $15 \pm 3\text{mA}$ .	
10.	Turn off power, then replace F <sub>802</sub> .	

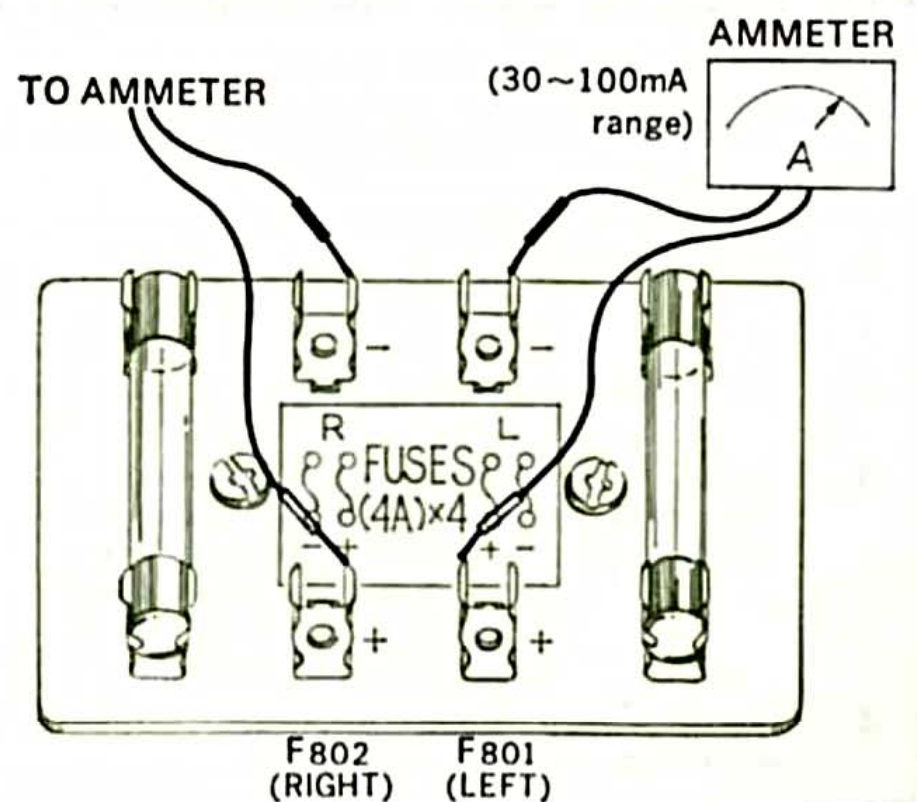

# ALIGNMENT

## FM ALIGNMENT PROCEDURE

NOTE: Set FM signal generator level to minimum first.

Equipment required: 1. Sweep Generator 2. Oscilloscope 3. FM Signal Generator 4. Multiplex Stereo Generator 5. AC V.T.V.M.

STEP	ALIGN	GENERATOR	FEED SIGNAL	OUTPUT INDICATOR	DIAL TO SET	ADJUST	ADJUST FOR
1	Discriminator.	Sweep generator 10.7MHz ±200kHz.	To TP <sub>101</sub> via 10pF ceramic capacitor.	Oscilloscope connected to 2F.		FM Discriminator transformer T <sub>201</sub> primary and secondary.	S curve.
2.	O.S.C.	FM signal generator 88MHz 400Hz 100% modulation.	To antenna terminals.	Oscilloscope and V.T.V.M. at output load.	88MHz.	O.S.C. coil L <sub>104</sub> .	Maximum.
3.	O.S.C.	FM signal generator 108MHz 400Hz 100% modulation.	Same as above.	Same as above.	108MHz.	O.S.C. trimmer TC <sub>104</sub> .	Maximum.
4	Repeat 2 and 3.						
5	RF Amp. Circuit.	FM signal generator 90MHz 400Hz 100% modulation.	Same as above.	Same as above.	90MHz.	Antenna coil L <sub>101</sub> , L <sub>102</sub> and L <sub>103</sub> .	Maximum.
6.	RF Amp. Circuit.	FM signal generator 106MHz 400Hz 100% modulation.	Same as above.	Same as above.	106MHz.	Trimmer TC <sub>101</sub> , TC <sub>102</sub> and TC <sub>103</sub> .	Maximum.
7	Repeat 5 and 6.						

## FM MULTIPLEX ALIGNMENT PROCEDURE

Do not attempt to align Multiplex Circuit unless following equipment is available:

1. Multiplex Stereo Generator 2. Oscilloscope 3. AC V.T.V.M. 4. Low Frequency Oscillator 5. FM Signal Generator

STEP	ALIGN	GENERATOR	FEED SIGNAL	OUTPUT INDICATOR	ADJUST	ADJUST FOR
1.	Separation VR.				VR <sub>401</sub> .	Fully counter- clockwise.
2.	67kHz Coil.	Low frequency oscillator 67kHz.	4A.	V.T.V.M. and Oscilloscope at TP <sub>401</sub> .	L <sub>404</sub> .	Minimum.
3.	Stereo separation 19kHz Coil.	FM signal generator 98MHz 100% modulation Stereo signal generator —composite signal with pilot signal, left channel, 40% modulation.	Antenna terminals Tune to signal.	V.T.V.M. and oscilloscope at right channel output load.	L <sub>406</sub> .	Channel-R minimum.
4.	Stereo separation VR.	Same as above.	Same as above.	Same as above.	VR <sub>401</sub> .	Same as above.

# AM ALIGNMENT PROCEDURE

NOTE: To align, set AM signal generator level to minimum.

STEP	ALIGN	GENERATOR	FEED SIGNAL	OUTPUT INDICATOR	DIAL SETTING	ADJUST	ADJUST FOR
1.	IF Transformer.	455kHz $\pm$ 30kHz Sweep-generator.	TP <sub>301</sub> .	Oscilloscope and V.T.V.M. at 3G.		I.F.T. T <sub>302</sub> , T <sub>304</sub> and T <sub>305</sub> .	Best IF wave form.
2.	O.S.C.	AM-generator 535kHz 400Hz 30% Modulation.	Antenna terminals	Oscilloscope and V.T.V.M. at output load.	535kHz.	O.S.C. coil T <sub>303</sub> .	Maximum.
3.	O.S.C.	AM-generator 1600kHz 400Hz 30% Modulation.	Same as above.	Same as above.	1600kHz.	O.S.C. trimmer cap. TC <sub>303</sub> .	Maximum.
4.	Repeat 2 and 3.						
5.	RF amp.	AM-generator 600kHz 400Hz 30% Modulation.	Same as above.	Same as above.	600kHz.	RF transformer T <sub>301</sub> .	Maximum.
6.	Antenna circuit.	Same as above.	Same as above.	Same as above.	600kHz.	Ferrite bar antenna coil L <sub>004</sub> .	Maximum.
7.	RF amp.	AM-generator 1400kHz 400Hz 30% Modulation.	Same as above.	Same as above.	1400kHz.	RF trimmer TC <sub>302</sub> .	Maximum.
8.	Antenna circuit.	Same as above.	Same as above.	Same as above.	1400kHz.	Antenna circuit trimmer TC <sub>301</sub> .	Maximum.
9.	Repeat 5, 6, 7, 8.						

**FM DISCRIMINATOR WAVE FORM**

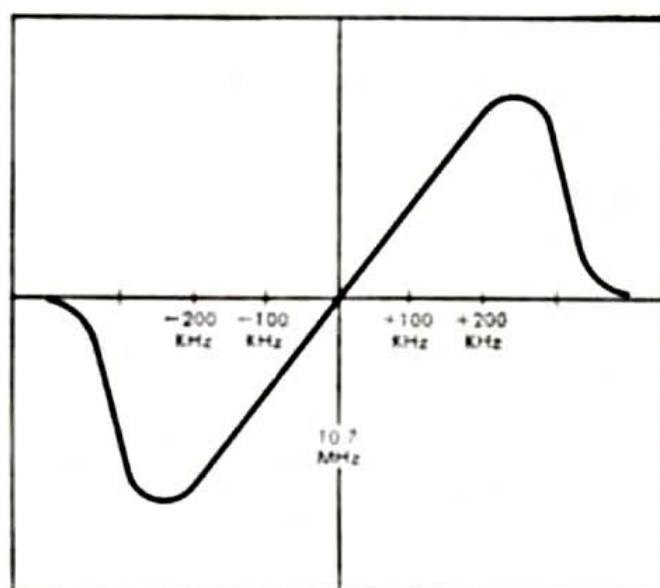

**AM IF WAVE FORM**

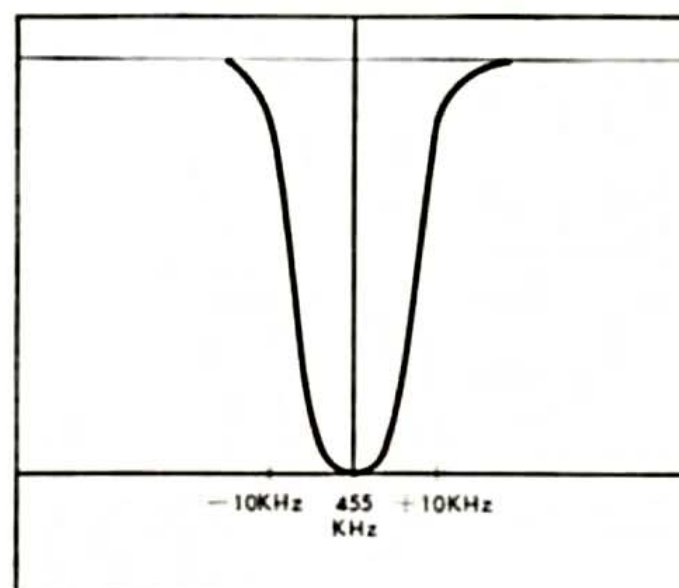

# PRINTED CIRCUIT BOARDS AND PARTS LIST

W: Parts No. X: Parts Name Y: Stock No. Z: Position of Parts

## FM IF BLOCK <F-1450A>

Stock No. 7520540

W	X	Y	Z
R201	220Ω	0100221	2C
R202	15kΩ	0100153	2C
R203	3.9kΩ	0100392	2C
R204	470Ω	0100471	2C
R205	390Ω	0101391	2C
R206	10Ω	0100100	1C
R207	680Ω	0101681	2C
R208	3.3kΩ	0101332	2C
R209	1.5kΩ	0100152	2C
R210	220Ω	0100221	2C
R211	1kΩ	0100102	2C
R212	390Ω	0101391	2C
R213	22Ω	0101220	1C
R214	680Ω	0101681	2B
R215	3.3kΩ	0101332	2B
R216	1.5kΩ	0100152	2B
R217	220Ω	0101221	2B
R218	1kΩ	0100102	2B
R219	390Ω	0101391	2B
R220	680Ω	0101681	2B
R221	330Ω	0101331	2B
R222	56Ω	0100560	2B
R223	22Ω	0101220	2B
R224	22Ω	0100220	2A
R225	5.6kΩ	0100562	2A
R226	1kΩ	0100102	1A
R227	1kΩ	0100102	1A
R230	100Ω	0101101	2A
R232	10kΩ	0101103	2A
R233	680Ω	0101681	1, 2C
R234	10kΩ	0101103	1C
R235	1.5kΩ	0101152	1C
R236	100Ω	0101101	1C
R237	1.5kΩ	0101152	1C
R238	330Ω	0100331	1C
R239	22kΩ	0100223	1C
R240	100kΩ	0101104	1C
R241	680Ω	0101681	1, 2B
R242	15kΩ	0100153	1B
R243	4.7kΩ	0100472	1B
R244	150Ω	0100151	1B
R245	820Ω	0100821	1B
R246	22Ω	0101220	1B
R247	100Ω	0101101	1, 2B
R248	15kΩ	0100153	1B
R249	1.8kΩ	0100182	1B
R250	270Ω	0100271	1B
R251	220Ω	0100221	1B
R252	2.2kΩ	0100222	1A
VR201	22kΩ (B)	FM Tuning Meter Adj.	1035150 1A
VR202		FM Signal Meter Adj.	1035150 1, 2A

W	X	Y	Z
C201	0.022μF	0657223	1, 2C
C202	0.022μF	0657223	2C
C203	0.022μF	0657223	1C
C204	0.022μF	0657223	2C
C205	0.022μF	0657223	2B, C
C206	0.022μF	0657223	2B
C207	0.047μF	0657473	1, 2B
C208	0.022μF	0657223	2B
C209	0.022μF	0657223	1A, B
C210	0.047μF	0657473	2A
C212	220pF	0660221	1A
C213	220pF	0660221	1A
C214	10μF	0512100	1A
C215	220pF	0660221	2A
C216	0.022μF	0657223	1A
C217	22pF	0660220	2C
C218	0.022μF	0657223	1C
C219	0.022μF	0657223	1C
C220	47pF	0660470	1C
C221	0.022μF	0657223	1C
C222	0.022μF	0657223	1B
C223	22pF	0660220	1B
C224	0.022μF	0657223	1B
C225	0.022μF	0657223	1B
C226	0.022μF	0657223	1B
C227	0.022μF	0657223	1B
C228	0.022μF	0657223	1A, B
C229	0.022μF	0657223	1A
C230	0.022μF	0657223	1A
C231	0.022μF	0657223	1A
C233	0.022μF	0657223	2B
TR201	25C930(D)	0305791	2C
TR202			2C
TR203			2B
TR204			1C
TR205			1B
TR206			1B
D201	IN60P	0311060	2A
D202		0311060	2A
D203	IN60	0310331	1C
D204		0310331	1C
D205	IS953	0311050	1A
D206	DS-430	0340090	1A
IC201	TA-7061AP	0360060	2B
CF201	SFA-10.7MC	0910100	2C
CF202		0910100	2C
CF203		0910100	2C
CF204		0910100	2B
CF205		0910100	2B
CF206		0910100	2B
T201	FM IFT	4235750	2A
T202		4235760	2A
T203		4235770	1B
T204		4235780	1A
L201	3.5μH Choke Coil	4290011	1B
	F-1450 Printed Circuit Board	2520320	

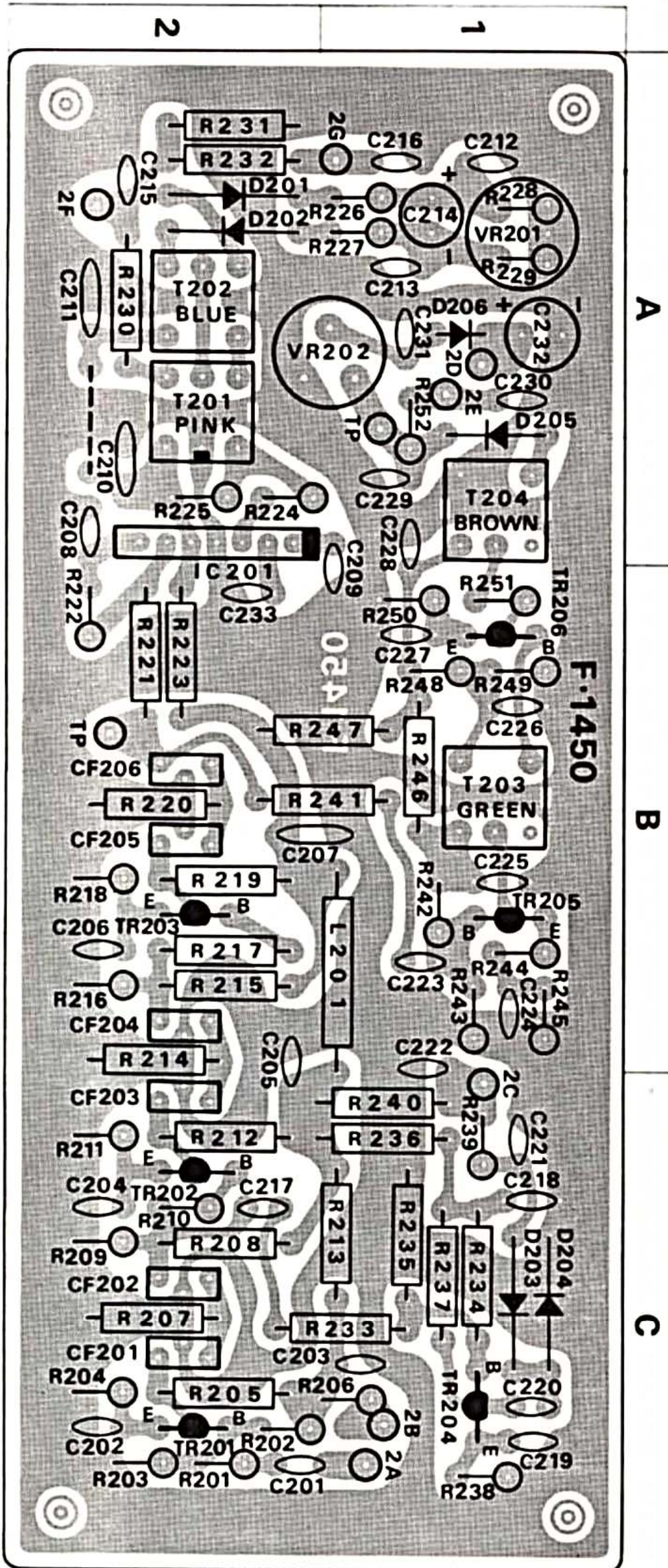

**Abbreviations**

<b>CR</b>	: Carbon Resistor
<b>CeR</b>	: Cement Resistor
<b>MFR</b>	: Metal Oxide Film Resistor
<b>AEC</b>	: Aluminum Solid Electrolytic Capacitor
<b>CC</b>	: Ceramic Capacitor
<b>BPEC</b>	: Bi-Polar Electrolytic Capacitor
<b>EC</b>	: Electrolytic Capacitor
<b>MC</b>	: Mylar Capacitor
<b>MPC</b>	: Metallized Polyester Capacitor
<b>SC</b>	: Styrol Capacitor



# PRINTED CIRCUIT BOARDS AND PARTS LIST

W: Parts No. X: Parts Name Y: Stock No. Z: Position of Parts

## FM MPX BLOCK <F-1387B>

StockNo. 7540670

W	X	Y	Z
R401	1kΩ	0100102	1 C
R402	100kΩ	0100104	1 C
R403	4.7kΩ	0100472	1 C
R404	22kΩ	0100223	1 C
R405	6.8kΩ	0100682	1 C
R406	100kΩ	0100104	1 B, C
R407	4.7kΩ	0100472	1 B
R408	820Ω	0100821	2 B
R409	2.2kΩ	0100222	2 B, C
R410	47kΩ	0100473	1 B
R412	1.8kΩ	0100182	1 B
R413	22kΩ	0100223	2 B, C
R414	100kΩ	0100104	2 B
R415	220kΩ	0100224	1 A, B
R416	220kΩ	0100224	1 A, B
R417	220kΩ	0100224	1 A, B
R418	220kΩ	0100224	1 B
R419	10kΩ	0100103	1 A
R420	10kΩ	0100103	1 A
R421	10kΩ	0100103	1 A
R422	10kΩ	0100103	1 A
R423	56kΩ	0100563	1 A
R424	56kΩ	0100563	1 A
R425	100kΩ	0100104	1 A
R426	100kΩ	0100104	1 A
R427	100kΩ	0100104	1 A
R428	100kΩ	0100104	1 A
R429	8.2kΩ	0100822	1 A
R430	8.2kΩ	0100822	1 A
R431	10kΩ	0100103	1 A
R432	10kΩ	0100103	1 A
R433	1kΩ	0100102	2 A
R434	1kΩ	0100102	1 A
R435	56kΩ	0100563	2 A
R436	56kΩ	0100563	2 A
R437	10kΩ	0100103	2 A
R438	10kΩ	0100103	2 A
R439	1MΩ	0100105	2 C
R440	3.3kΩ	0100332	2 B, C
R441	82Ω	0100820	2 C
R442	47kΩ	0100473	2 C
R443	8.2kΩ	0100822	2 C
R444	47kΩ	0100473	2 C
R445	47Ω	0100470	2 C
R446	22kΩ	0100223	2 C
R447	22kΩ	0100223	2 C
R448	1kΩ	0100102	2 C
R449	8.2kΩ	0100822	1, 2 B
R450	15Ω	0100150	2 B
R451	22kΩ	0100223	2 B
R452	120Ω	0100121	2 B
R453	22kΩ	0100223	2 B
R454	22kΩ	0100223	2 B
R455	47kΩ	0100473	2 B
R456	4.7kΩ	0100472	2 B

±10% 1/4W CR.

W	X	Y	Z
R457	4.7kΩ	0101472	2 A
R458	47Ω	0100470	2 B
R459	47kΩ	0100473	2 B
R460	47kΩ	0100473	2 C
R461	47kΩ	0100473	2 C
R462	39kΩ	0100393	1 C
R463	100kΩ	0107104	2 C
VR401	10kΩ (B) Stereo Separation Adj.	1035130	1 A
VR402	220kΩ (B) Stereo Indicator Adj.	1035210	2 C
VR403	220kΩ (B) FM Muting Adj.	1035210	2 B, C
C401	68pF ±10% 50 V CC.	0660680	1 C
C402	3.3μF 50 V EC.	0515339	1 C
C403	6800pF ±5% 50 V SC.	0629001	1 C
C404	2200pF ±5% 50 V SC.	0620222	2 B
C405	10μF 25 V EC.	0513100	1 B
C406	1μF 50 V EC.	0515109	2 B
C411	560pF ±5% 50 V SC.	0620561	1 A
C412	560pF ±5% 50 V SC.	0620561	1 A
C413	0.1μF ±10% 50 V MC.	0601108	1 A
C414	0.1μF ±10% 50 V MC.	0601108	1 A
C415	1600pF ±5% 50 V SC.	0620162	1 A
C416	1600pF ±5% 50 V SC.	0620162	1 A
C417	1μF 50 V EC.	0515109	1, 2 B
C418	0.0022μF ±10% 50 V MC.	0601226	2 A
C419	0.47μF 25 V AEC.	0563478	2 A
C420	0.47μF 25 V AEC.	0563478	1, 2 A
C423	1200pF ±5% 50 V SC.	0620122	2 A
C424	1200pF ±5% 50 V SC.	0620122	2 A
C425	0.001μF ±10% 50 V MC.	0601106	2 A, B
C426	0.001μF ±10% 50 V MC.	0601106	2 A
C427	100pF ±5% 50 V SC.	0620101	1 C
C428	4700pF ±5% 50 V SC.	0620472	2 C
C429	680pF ±5% 50 V SC.	0620681	2 C
C430	1μF 50 V EC.	0515109	2 C
C431	10μF 25 V EC.	0513100	2 B
C432	0.1μF 25 V AEC.	0563108	2 B
C433	0.047μF +80% -20% 50 V CC.	0657473	2 B
C434	47μF 25 V EC.	0513470	1, 2 C
C435	0.022μF +80% -20% 50 V CC.	0657223	
C436	220μF 25 V EC.	0513221	
C437	0.047μF +80% -20% 50 V CC.	0657473	2 C
TR401	2SC871 (F)	0305472	1 C
TR402	2SA678 (6)	0300291	1, 2 B
TR403	2SC871 (F)	0305472	1 A
TR404	2SC871 (F)	0305472	1 A
TR405	2SC634A (6)	0305891	2 A
TR406	2SC634A (6)	0305891	2 A
TR407	2SC711 (F)	0305732	2 C
TR408	2SC711 (E, F)	0305731, 2	2 C
TR409	2SC711 (E, F)	0305731, 2	2 C
TR410	2SC711 (E, F)	0305731, 2	2 C
TR411	2SC711 (E, F)	0305731, 2	2 B
TR412	2SC634A (6)	0305891	2 B
TR413	2SC711 (F)	0305732	2 B
TR414	2SC711 (E, F)	0305731, 2	2 B

W	X	Y	Z
TR415	2SA678 (6)	0300291	2B
TR416	2SC711 (E, F)	0305731. 2	2C
D401	IS953	0311050	1C
D402		0311050	1C
D403	IN60P	0311060	1B
D404		0311060	1B
D405		0311060	1B
D406		0311060	1B
D407	IN34A	0310400	2C
L401	MPX Coil	4240660	1B, C
L402	2.2mH Micro Inductor	4900090	1C
L403		4900090	1C
L404	MPX Coil	4240650	1B
L405	1mA Micro Inductor	4900120	2C
L406	MPX Coil	4240640	1C
L407		4240570	2A
L408		4240570	1A
F-1387-2 Printed Circuit Board		2540260	

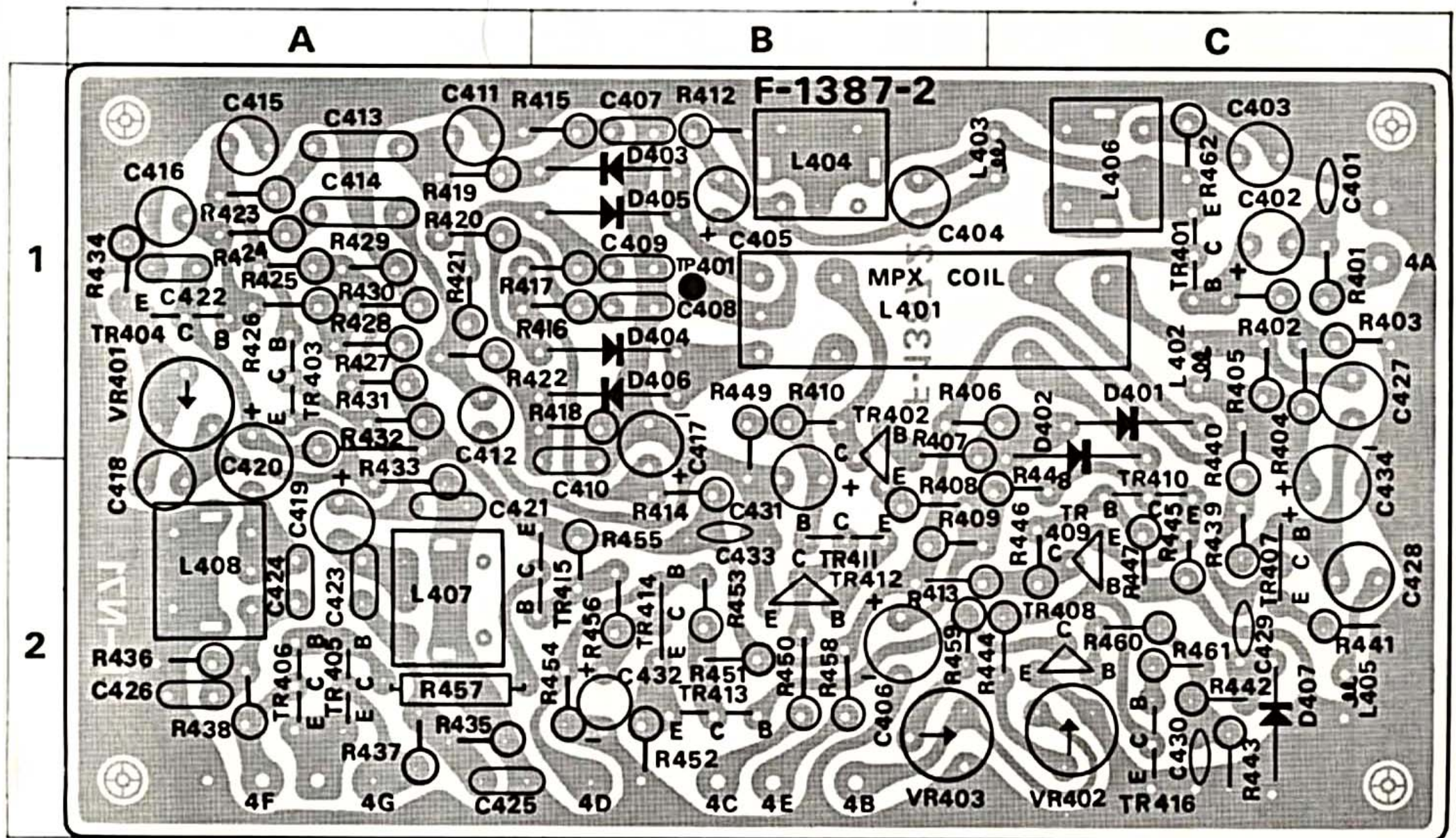

# PRINTED CIRCUIT BOARDS AND PARTS LIST

W: Parts No. X: Parts Name Y: Stock No. Z: Position of Parts

## AM IF BLOCK <F-1417C>

Stock No. 7530230

W	X	Y	Z	W	X	Y	Z
R301	10kΩ	0101103	1, 2C	C314	10pF	0660100	1C
R302	1kΩ	0101102	1, 2C	C315	15pF } ±10% 50 V CC.	0660150	1B
R303	3.3kΩ	0101332	2C	C316	0.047μF } +80% 25 V CC.	0656473	1C
R304	100Ω	0101101	1C	C317	0.047μF } -20%	0656473	1B
R305	10kΩ	0101103	1C	C318	10μF	0512100	1B
R306	10kΩ	0101103	2B, C	C319	0.047μF } +80% 25 V CC.	0656473	1B
R307	22Ω	0101220	2C	C320	0.047μF } -20%	0656473	2B
R308	1kΩ	0101102	1C	C321	1μF	0515109	1B
R309	470Ω	0101471	2C	C322	0.047μF } +80% 25 V CC.	0656473	2B
R310	100Ω	0101101	1, 2C	C323	0.047μF } -20%	0656473	2B
R311	47Ω	0101470	1B, C	C324	0.047μF } +80% 25 V CC.	0656473	2B
R312	1kΩ	0101102	1B	C325	0.047μF } -20%	0656473	2A
R313	22kΩ	0101223	1B, C	C326	47pF ±10% 50 V CC	0660470	2A, B
R314	1kΩ	0101102	1C	C327	0.047μF } +80% 25 V CC.	0657473	2A
R315	3.3kΩ	0101332	1C	C328	0.047μF } -20%	0657473	1A
R316	1kΩ	0101102	2B	C329	4.7μF	0513479	1A
R317	150kΩ	0101151	1B	C330	0.0047μF } ±10% 50 V MC.	0601476	2A
R318	5.6kΩ	0101562	1B	C332	0.01μF	0601107	1A
R319	10kΩ	0101103	2B	C333	0.0047μF	0601476	2A
R320	1.5kΩ	0101152	2B	C334	0.01μF	0601107	1, 2A
R321	100kΩ	0101104	2B	C335	0.01μF	0601107	2A
R322	100Ω	0101101	2B	C336	0.01μF	0601107	1A
R323	47Ω	0101470	2B	C337	0.047μF	0601477	2A
R324	4.7kΩ	0101472	2B	C338	0.047μF } +80% 25 V CC.	0656473	1B
R325	10kΩ	0101103	2B	C339	47μF	0512470	1B
R326	1.8kΩ	0101182	1B	C340	0.047μF } +80% 25 V CC.	0656473	1B
R327	1kΩ	0101102	2A	C341	0.022μF } -20%	0656223	1B
R328	100Ω	0101101	1A, B	C342	0.022μF } +80% 25 V CC.	0656223	1A
R329	1.8kΩ	0101182	1A, B	C343	0.022μF } -20%	0656223	1A
R330	1kΩ	0101102	2A	C344	100μF	0515101	1A
R331	10kΩ	0101103	1A	TR301	2SC403C (4)	0305992	2C
R332	18kΩ	0101183	1A	TR302		0305992	2C
R333	10kΩ	0101103	1A	TR303		0305991	1C
R334	47kΩ	0101473	2A	TR304		0305992	1B
R335	15kΩ	0101153	1B	TR305		0305992	2B
R336	22kΩ	0101223	1B	TR306		0305991	1B
R337	100Ω	0101101	1B	D301	IN60	0310330	1C
R338	2.2kΩ	0101222	1A, B	D302	IS1007	0311090	2A
R339	1kΩ	0101102	1A	D303	IN60	0310330	1A
R340	100Ω	0101101	2A	D304		0310330	1A
R341	8.2Ω	0107829	1C	T301	AM RF Coil	4210180	2C
VR301	10kΩ (B) AM Meter Adj.	1035130	1A	T302	Ceramic Filter YEL-455E2	0910180	2B, C
C301	0.022μF } +80% 25 V CC.	0656223	1C	T303	AM OSC Coil	4220480	1A, B
C302	1μF } -20% 50 V EC.	0515109	1C	T304	AM IFT	4230590	2B
C303	0.047μF } +80% 25 V CC.	0656473	1C	T305	AM IFT	4230600	2B
C304	0.047μF } -20%	0656473	2C	T306	AM IFT	4230580	2A
C305	0.022μF	0656223	2C	L301	3.3μH Micro Inductor	4900100	2C
C306	0.047μF	0656473	2C	L302	59mH Coil	4290200	2A
C307	1μF	0515109	2C	L303		4290200	2A
C308	0.047μF } +80% 50 V CC.	0656473	2C	F-1417 Printed Circuit Board			2530160
C309	0.047μF } -20%	0656473	2C				
C310	0.047μF	0656473	2C				
C311	0.01μF ±10% 50 V MC.	0601107	1C				
C312	470pF ±5% 50 V SC.	0620471	1B				
C313	0.01μF ±10% 50 V MC.	0601107	1C				

# ACCESSORY (A) BLOCK <F-1437>

Stock No. 7591170

W	X	Y
S2	N.R. Adaptor Switch	1130610
S3	Tape Mon-1 Switch	
S4	Tape Mon-2 Switch	
S5	4Ch. Adaptor Switch	
S13	FM Muting Off Switch	
S2'	(N.R. Adaptor Switch)	1110210
S3'	(Tape Mon-1 Switch)	1110210
S4'	(Tape Mon-2 Switch)	1110210
F-1437 Printed Circuit Board		2591170

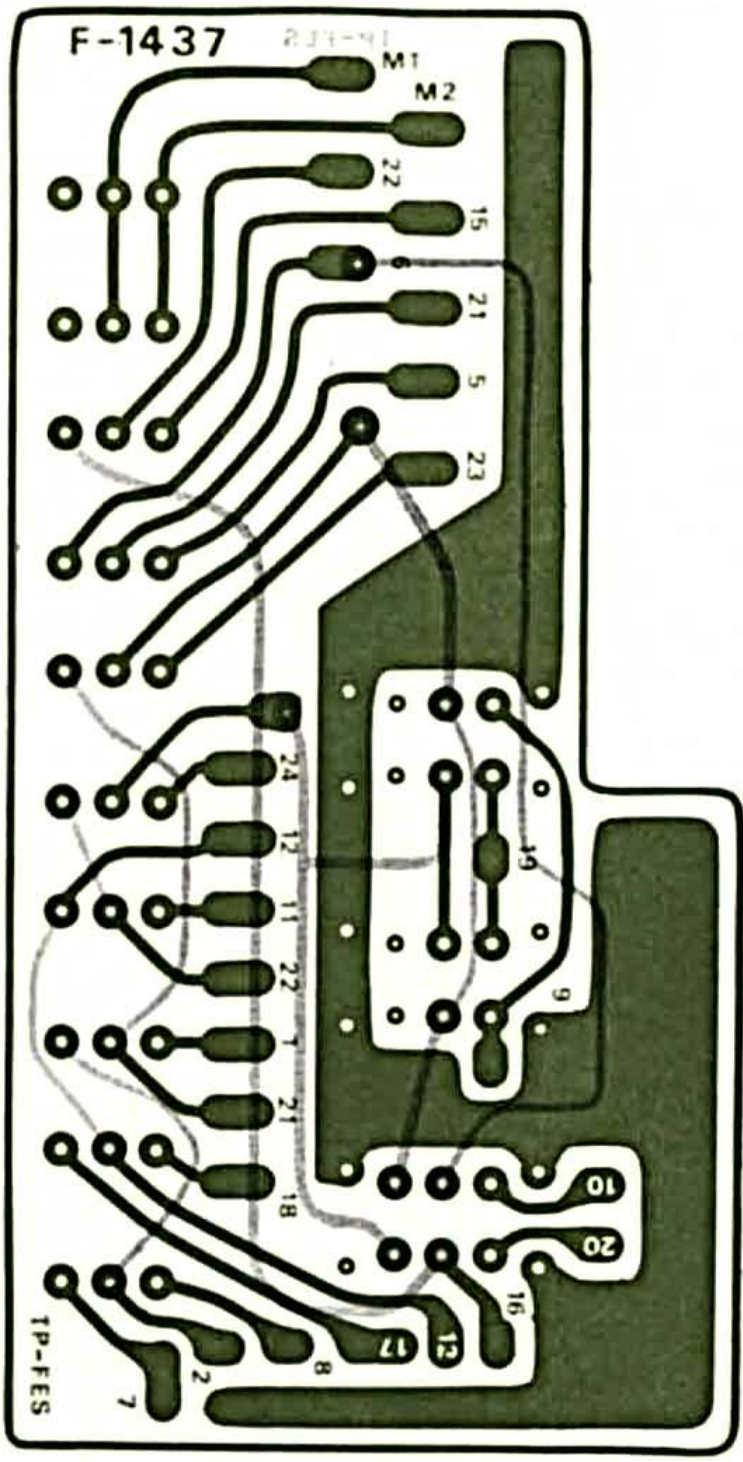
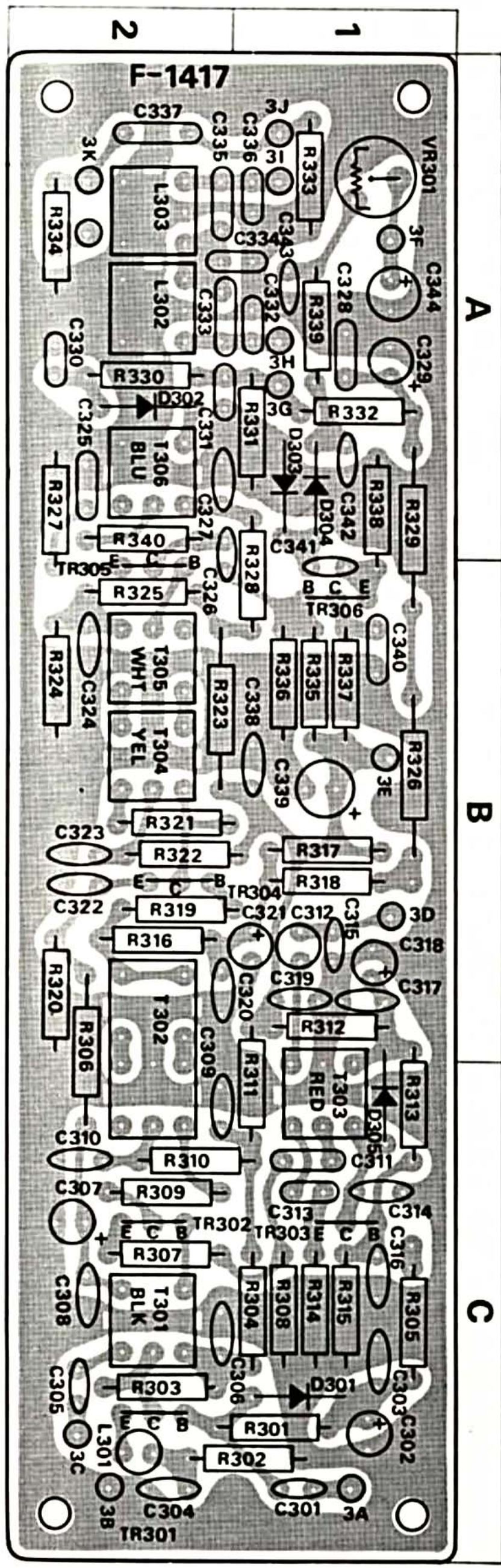

# PRINTED CIRCUIT BOARDS AND PARTS LIST

W: Parts No. X: Parts Name Y: Stock No. Z: Position of Parts

## EQUALIZER BLOCK <F-1435>

Stock No. 7550410

W	X	Y	Z
R601	47kΩ	0101473	2 B
R602	47kΩ	0101473	2 A
R603	3.3kΩ	0101332	1 B
R604	3.3kΩ	0101332	1 A
R605	47kΩ	0101473	1 B
R606	47kΩ	0101473	1 A
R607	47kΩ	0101473	1 B
R608	47kΩ	0101473	1 A
R609	680Ω	0101681	1, 2 B
R610	680Ω	0101681	1, 2 A
R611	150kΩ	0101154	2 B
R612	150kΩ	0101154	2 A
R613	220kΩ	0101224	1 B
R614	220kΩ	0101224	1 A
R615	22kΩ	0101223	1 B
R616	22kΩ	0101223	1 A
R617	470kΩ	0101474	2 B
R618	470kΩ	0101474	2 A
R619	27kΩ	0101273	2 B
R620	27kΩ	0101273	2 A
R621	3.3kΩ	0101332	2 B
R622	3.3kΩ	0101332	2 A
R623	180Ω	0101181	2 B
R624	180Ω	0101181	2 A
R625	47kΩ	0101473	2 B
R626	47kΩ	0101473	2 A
R627	10kΩ	0101103	2 B

±10% ¼W CR.

W	X	Y	Z
R628	10kΩ	0101103	2 A
R629	1kΩ	0101102	2 B
R630	1kΩ	0101102	2 A
R631	33kΩ	0101333	2 B
R632	33kΩ	0101333	2 A
R633	33kΩ	0101333	2 B
R634	33kΩ	0101333	2 A
C601	1.5μF	0573159	1 B
C602	1.5μF	0573159	1 A
C603	1μF	0515109	1 B
C604	1μF	0515109	1 A
C605	10μF	0515100	1 B
C606	10μF	0515100	1 A
C607	33pF	0660330	1 B
C608	33pF	0660330	1 A
C609	47μF	0511470	1 B
C610	47μF	0511470	1 A
C611	33μF	0510330	1 B
C612	33μF	0510330	1 A
C613	470pF	0640471	2 B
C614	470pF	0640471	2 A
C615	0.47μF	0601478	2 B
C616	0.47μF	0601478	2 A
C617	10μF	0513100	2 B
C618	10μF	0513100	2 A

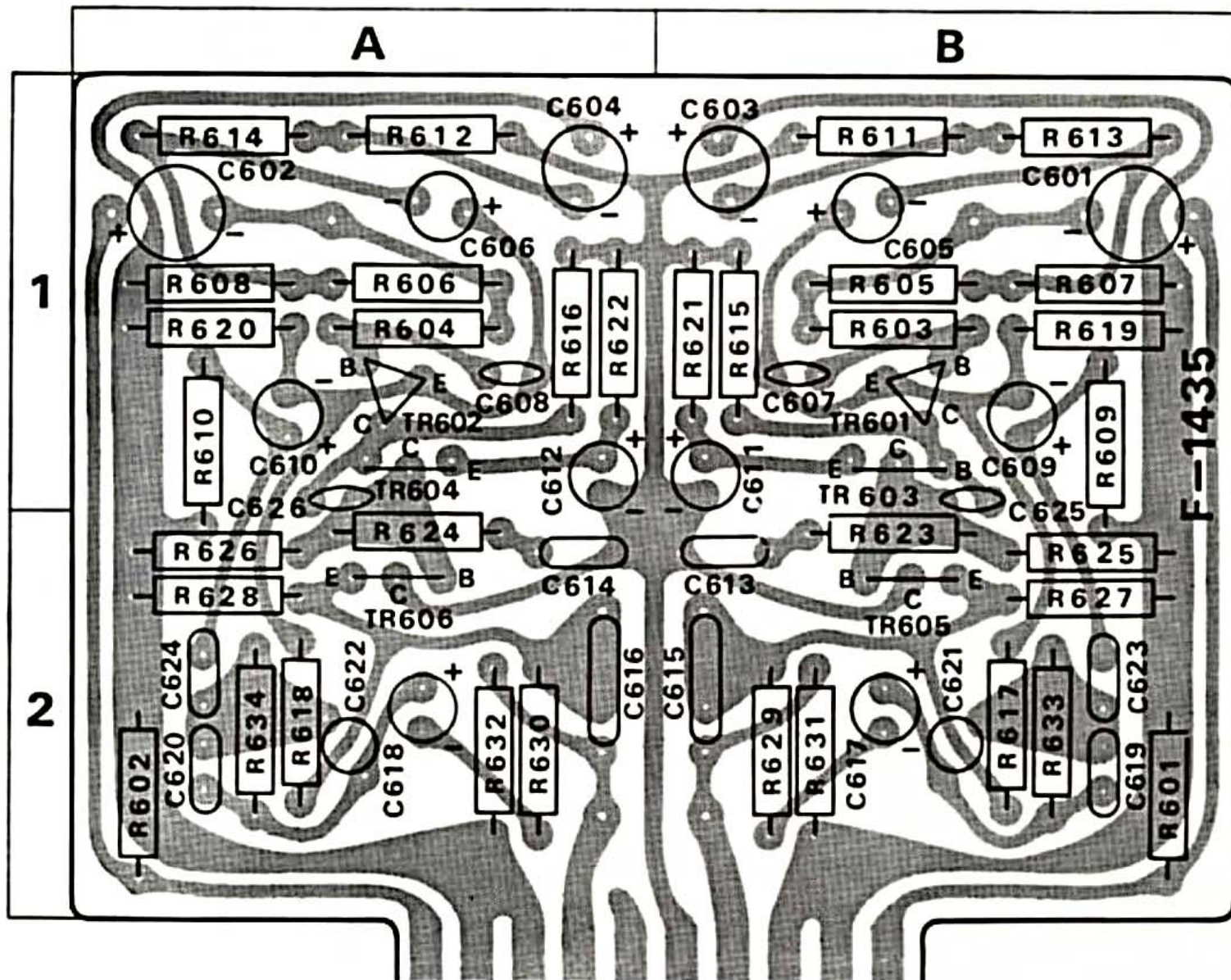

ACCESSORY (B) BLOCK <F-1438>

Stock No. 7591180

W	X	Y	Z
C619	0.0022 $\mu$ F	0601226	2 B
C620	0.0022 $\mu$ F	0601226	2 A
C621	470 pF	0621471	2 B
C622	470 pF	0621471	2 A
C623	0.0068 $\mu$ F	0601686	2 B
C624	0.0068 $\mu$ F	0601686	2 A
C625	22 pF	0660220	2 B
C626	22 pF	0660220	2 A
±10% 50 V MC.			
±10% 50 V SC.			
±10% 50 V MC.			
±10% 50 V CC.			
TR601	2SA640 (L, M)	0300301, 2	1 B
TR602		0300301, 2	1 A
TR603	2SC1222 (E)	0306012	1 B
TR604		0306012	1 A
TR605	2SA640 (L, M)	0300301, 2	2 B
TR606		0300301, 2	2 A
F-1435 Printed Circuit Board		2550320	

W	X	Y	Z
R791	22k $\Omega$	0101223	B
R792	22k $\Omega$	0101223	B
R793	12k $\Omega$	0101123	B
R794	12k $\Omega$	0101123	B
R797	470k $\Omega$	0101474	A
R798	470k $\Omega$	0101474	A
±10% 1/4W CR.			
C791	390 pF	0640391	B
C792	390 pF	0640391	B
C793	0.02 $\mu$ F	0601207	B
C794	0.02 $\mu$ F	0601207	B
C795	0.008 $\mu$ F	0601806	A
C796	0.008 $\mu$ F	0601806	A
±5% 50 V MiC.			
±10% 50 V MC.			
S6	Mono Switch	1130600	
S7	Loudness Switch		
S8	High Filter Switch		
S9	Low Filter Switch		
F-1438 Printed Circuit Board		2591180	

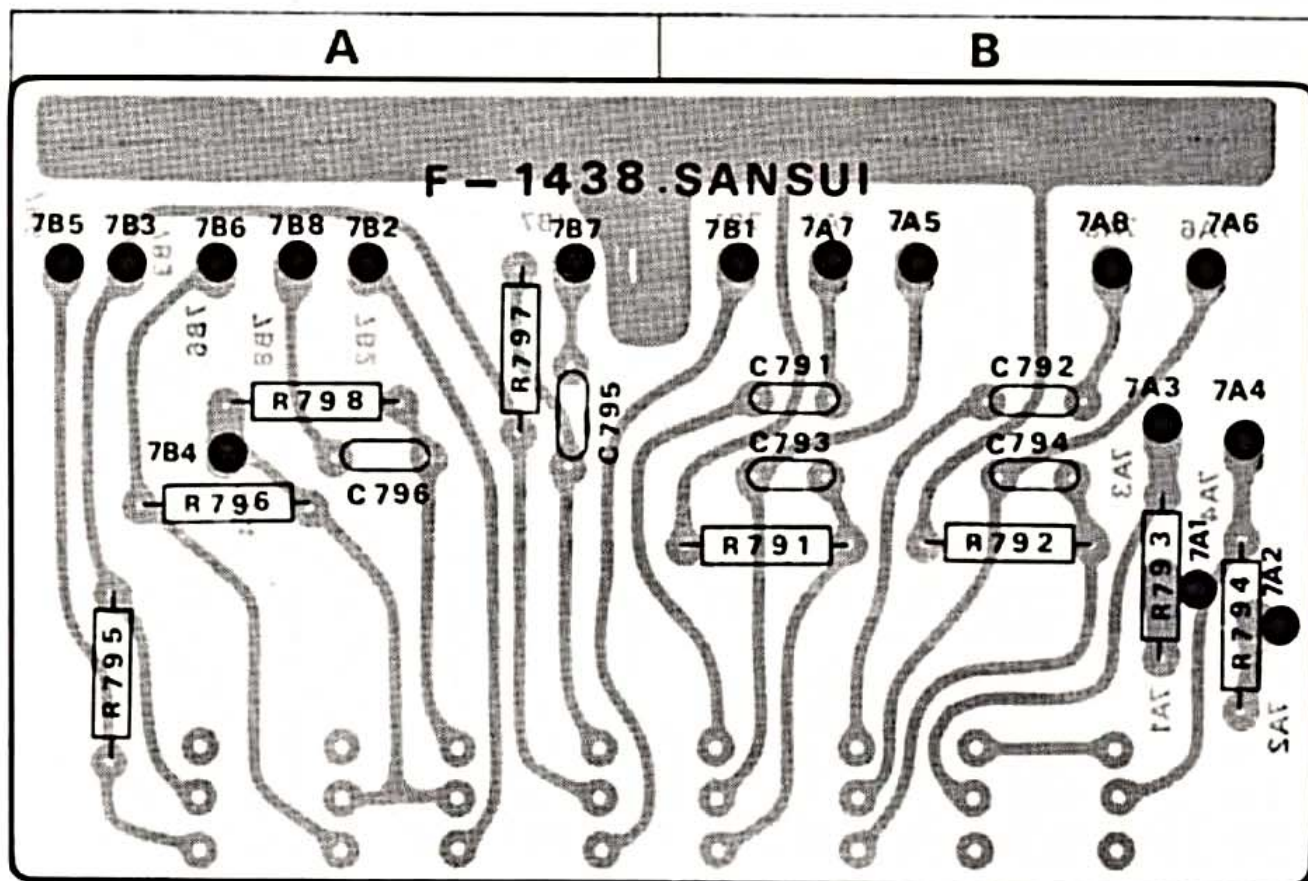

# PRINTED CIRCUIT BOARDS AND PARTS LIST

W: Parts No. X: Parts Name Y: Stock No. Z: Position of Parts

## TONE CONTROL BLOCK <F-1436>

Stock No. 7560560

W	X	Y	Z	W	X	Y	Z
R701	2.7k $\Omega$	0101272	2 A	R756	2.7k $\Omega$	0101272	1 C
R702	2.7k $\Omega$	0101272	1 A	R757	1.5k $\Omega$	0101152	1 C
R703	150k $\Omega$	0101154	2 A	R758	1.5k $\Omega$	0101152	1 C
R704	150k $\Omega$	0101154	1 A	R759	47k $\Omega$	0101473	2 C
R705	330k $\Omega$	0101334	2 A	R760	47k $\Omega$	0101473	1 C
R706	330k $\Omega$	0101334	1 A	R761	47k $\Omega$	0101473	2 C
R707	100k $\Omega$	0101104	2 A	R762	47k $\Omega$	0101473	1 C
R708	100k $\Omega$	0101104	1 A	R763	1k $\Omega$	0101102	1 C
R709	120k $\Omega$	0101124	2 A	R764	1k $\Omega$	0101102	1 C
R710	120k $\Omega$	0101124	1 A	R765	220k $\Omega$	0101224	1 C
R711	18k $\Omega$	0101183	2 A	R766	220k $\Omega$	0101224	1 C
R712	18k $\Omega$	0101183	1 A	R767	150k $\Omega$	0101154	1 C
R713	2.7k $\Omega$	0101272	2 A	R768	150k $\Omega$	0101154	1 C
R714	2.7k $\Omega$	0101272	1 A	R769	5.6k $\Omega$	0101562	1 C
R715	3.3k $\Omega$	0101332	2 A	R770	5.6k $\Omega$	0101562	1 C
R716	3.3k $\Omega$	0101332	1 A	R771	47k $\Omega$	0101473	1 C
R717	470 $\Omega$	0101471	2 A	R772	47k $\Omega$	0101473	1 C
R718	470 $\Omega$	0101471	1 A	R773	100 $\Omega$	0101101	1 B, C
R719	3.3k $\Omega$	0101332	2 A	R774	100 $\Omega$	0101101	1 A, B
R720	3.3k $\Omega$	0101332	2 B	R775	4.7 $\Omega$	0100479	2 C
R721	1.2k $\Omega$	0101122	2 A	R776	4.7 $\Omega$	0100479	2 B
R722	1.2k $\Omega$	0101122	2 B	R777	470k $\Omega$	0101474	1 C
R723	3.9k $\Omega$	0101392	2 A	R778	470k $\Omega$	0101474	1 C
R724	3.9k $\Omega$	0101392	2 B	R779	100 $\Omega$	0101101	1, 2 C
R725	1.2k $\Omega$	0101122	2 A				
R726	1.2k $\Omega$	0101122	2 B	C701	0.47 $\mu$ F	0601478	2 A
R727	3.3k $\Omega$	0101332	1, 2 B	C702	0.47 $\mu$ F	0601478	1 A
R728	3.3k $\Omega$	0101332	1 B	C703	68pF	0660680	2 A
R729	680 $\Omega$	0101681	1, 2 B	C704	68pF	0660680	1 A
R730	680 $\Omega$	0101681	1 C	C705	33 $\mu$ F	0510330	2 A
R731	220 $\Omega$	0101221	2 B	C706	33 $\mu$ F	0510330	1 A
R732	220 $\Omega$	0101221	1, 2 B	C707	33 $\mu$ F	0510330	2 A
R733	5.6k $\Omega$	0101562	2 B	C708	33 $\mu$ F	0510330	1 A
R734	5.6k $\Omega$	0101562	1, 2 B	C709	10 $\mu$ F	0515100	2 A
R735	10k $\Omega$	0101103	2 B	C710	10 $\mu$ F	0515100	1 A
R736	10k $\Omega$	0101103	1, 2 B	C711	0.01 $\mu$ F	0601107	2 B
R737	5.6k $\Omega$	0101562	2 B	C712	0.01 $\mu$ F	0601107	2 B
R738	5.6k $\Omega$	0101562	1, 2 B	C713	0.01 $\mu$ F	0601107	2 B
R739	1.2k $\Omega$	0101122	2 B	C714	0.01 $\mu$ F	0601107	2 B
R740	1.2k $\Omega$	0101122	1 C	C715	0.033 $\mu$ F	0601337	2 B
R741	3.9k $\Omega$	0101392	1, 2 B	C716	0.033 $\mu$ F	0601337	2 B
R742	3.9k $\Omega$	0101392	1 B	C717	0.033 $\mu$ F	0601337	2 B
R743	100k $\Omega$	0101104	1 A	C718	0.033 $\mu$ F	0601337	1, 2 B
R744	100k $\Omega$	0101104	1 B	C719	3.3 $\mu$ F	0515339	1, 2 A
R745	100k $\Omega$	0101104	1 B	C720	3.3 $\mu$ F	0515339	1 B
R746	100k $\Omega$	0101104	1 B	C721	10 $\mu$ F	0515100	1 B
R747	8.2k $\Omega$	0101822	1 B	C722	10 $\mu$ F	0515100	2 B
R748	8.2k $\Omega$	0101822	1 B	C723	47pF	0660470	1 A
R749	470k $\Omega$	0101474	1 B	C724	47pF	0660470	1 B
R750	470k $\Omega$	0101474	1 B	C725	33 $\mu$ F	0510330	1 A
R751	680 $\Omega$	0101681	1 A	C726	33 $\mu$ F	0510330	1 B
R752	680 $\Omega$	0101681	1 B	C727	2.2 $\mu$ F	0573229	2 B
R753	3.3k $\Omega$	0101332	1 B	C728	2.2 $\mu$ F	0573229	1 B
R754	3.3k $\Omega$	0101332	1 B	C729	0.04 $\mu$ F	0601407	2 C
R755	2.7k $\Omega$	0101272	2 C	C730	0.04 $\mu$ F	0601407	1 C

W	X	Y	Z
C731	0.03 $\mu$ F	±10% 50 V MC.	0601307 2C
C732	0.03 $\mu$ F		0601307 1C
C733	0.68 $\mu$ F	±20% 25 V TC.	0573688 2C
C734	0.68 $\mu$ F		0573688 1C
C735	0.022 $\mu$ F	±10% 50 V MC.	0601227 2C
C736	0.022 $\mu$ F		0601227 1C
C737	1 $\mu$ F	±20% 25 V TC.	0573109 2C
C738	1 $\mu$ F		0573109 1C
C739	100 $\mu$ F	35 V EC.	0514101 1A
C740	100 $\mu$ F	50 V EC.	0515101 1, 2C
TR701	25A640 (M, L)	0300301.2	2A
TR702		0300301.2	1A
TR703		0300301.2	2A
TR704		0300301.2	1A
TR705		0300301.2	1A
TR706		0300301.2	1B
TR707		0300301.2	1B
TR708		0300301.2	1B
TR709		0300301.2	2C
TR710		0300301.2	1C
F-1436 Printed Circuit Board		2560520	

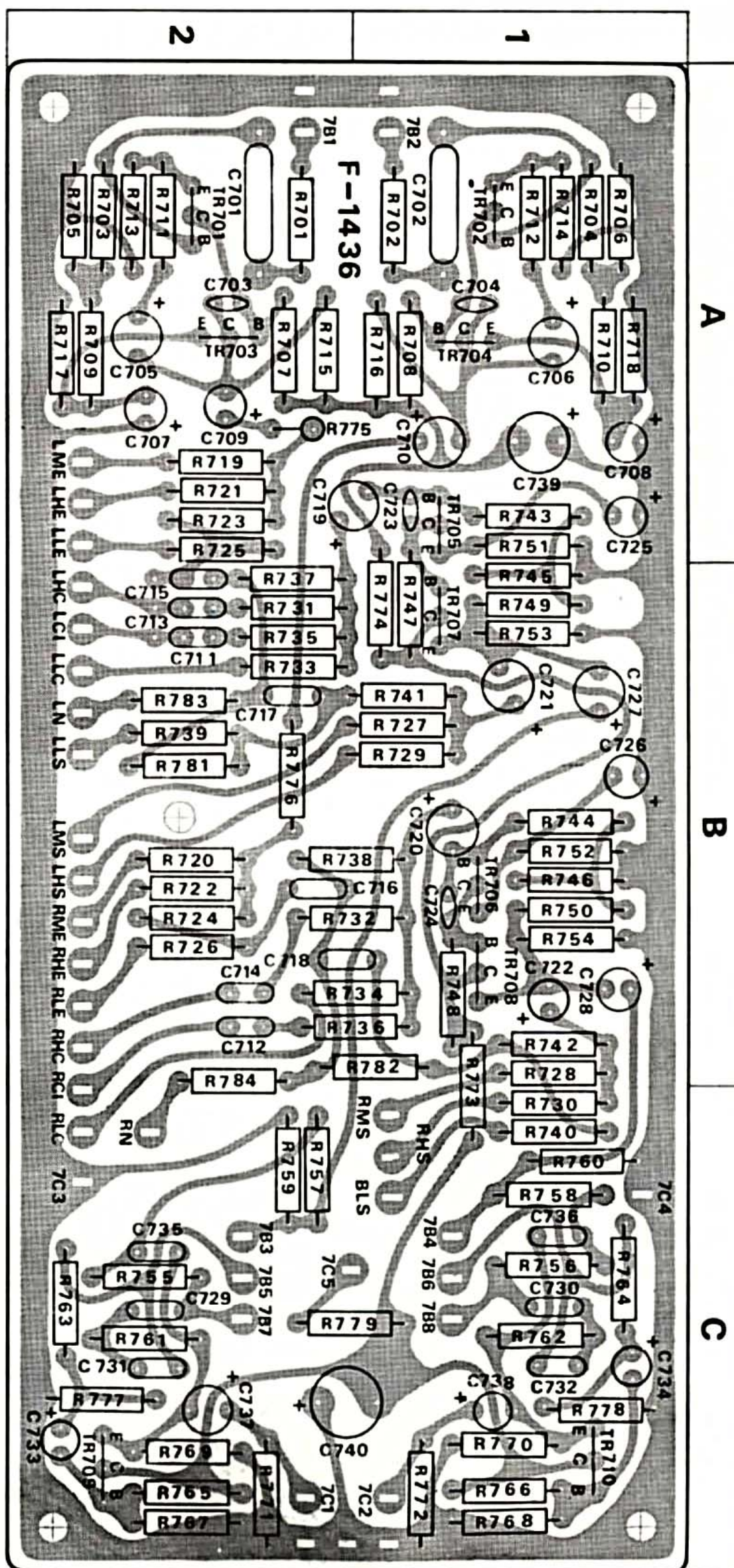

### LAMP HOLDER BLOCK <F-1205> Stock No. 7590520

W	X	Y
PL006	7V 0.3A Pilot Lamp (Fuse Type)	0420040
PL007		0420040
PL008		0420040
PL009		0420040
PL010		0420040
Fuse Holder (× 10)		2310050
F-1205 Printed Circuit Board		2590520



# PRINTED CIRCUIT BOARDS AND PARTS LIST

W: Parts No. X: Parts Name Y: Stock No. Z: Position of Parts

## DRIVER BLOCK <F-1439>

Stock No. 7570660

W	X	Y	Z
R801	470kΩ	0101474	2 A
R802	10kΩ	0101103	2 A
R803	100kΩ	0101104	1 A
R804	8.2kΩ	0101822	1 A
R805	47kΩ	0101473	1 A
R806	10kΩ	0101103	1 A
R807	6.8kΩ	0101682	1 A
R808	6.8kΩ	0101682	2 A
R809	220Ω	0101221	2 A
R810	100kΩ	0101104	2 A, B
R811	3.9kΩ	0101392	2 A
R812	8.2kΩ	0101822	1 A
R813	470Ω	0101471	1 B
R814	47kΩ	0101472	1 B
R815	100Ω	0101101	1 A, B
R816	100Ω	0101101	1 A, B
R817	470Ω	0103471	1 A, B
R818	5.6kΩ	0101562	1 B
R819	1.5kΩ	0101152	1 B
R820	33Ω	0101330	1 B
R821	6.8Ω	0101689	2 A, B
R822	4.7kΩ	0101472	2 A, B
R823	10Ω	0103100	2 B
R824	10Ω	0103100	2 B
R827	6.8Ω	0101689	2 B
R828	6.8Ω	0101689	2 B

W	X	Y	Z
R831	220Ω	0101221	2 B
R832	220Ω	0101221	2 B
R833	10Ω	0132100	2 A
VR801	5kΩ (B)	1031090	1 A
VR802	1kΩ (B)	1031050	1 B
C801	1.5μF ±20% 25V TC.	0573159	2 A
C802	47pF ±10% 50 V CC.	0660470	1, 2 A
C803	0.001μF +80% -20% 50 V CC.	0657102	2 A
C804	22pF ±10% 50 V CC.	0660220	2 A
C805	15pF ±10% 50 V CC.	0660150	2 A, B
C806	100μF 10 BpEC.	0531101	2 A
C807	0.1μF ±10% 50 V MC.	0601108	2 A
C808	22pF ±10% 50 V CC.	0660220	1 B
C809	47μF 50 V EC.	0515470	2 A
C810	22pF ±10% 50 V CC.	0660220	1 A
C811	0.0022μF +80% -20% 50 V CC.	0657222	1 B
TR801	2SA640 (L <sub>1</sub> , L <sub>2</sub> )	0300302.4	1 A
TR802		0300302.4	2 A
TR803	2SA678 (6, 7)	0300291.2	1 B
TR804		0300291.2	2 A
TR805	2SC983 (O, R)	0306021.2	1 A
TR806		0306021.2	1 A, B
TR807	2SC984 (C)	0305872	1 A

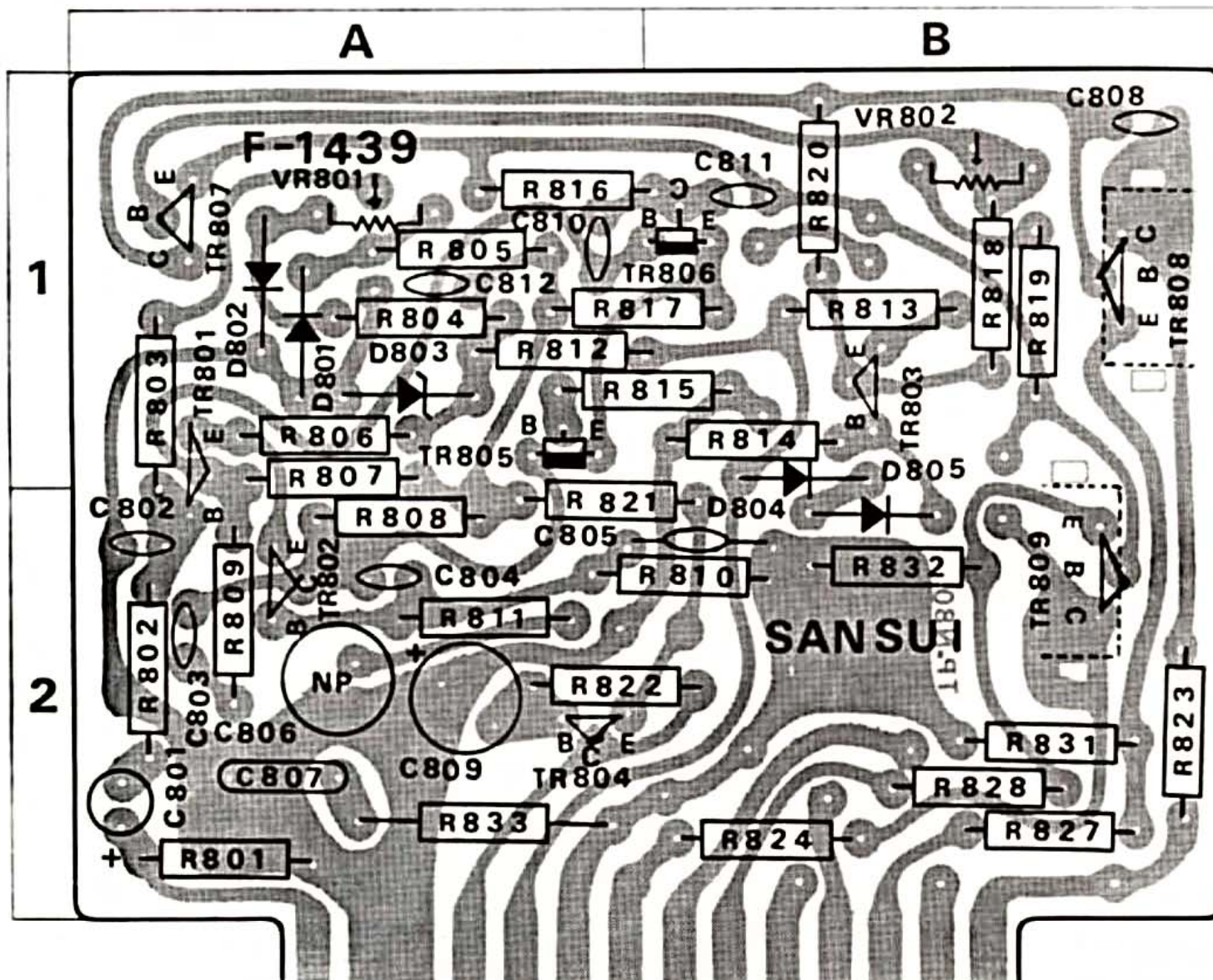

# PROTECTOR BLOCK <F-1440>

Stock No. 7598110

W	X	Y	Z
TR808	2SC1124 (2, 3)	0305901, 2	2 A
TR809	2SA706 Green (2)	0300401	2 B
D801	1S953	0311050	1 A
D802		0311050	1 A
D803	RD-9A (M)	0315220	1 A
D804	1S953	0311050	2 B
D805		0311050	1 B
	F-1439 Printed Circuit Board	2570450	

W	X	Y	Z
R901	47kΩ ±10% ¼W CR.	0100473	A
R902	82kΩ ±5% ¼W CR.	0106823	A
R903	3.3kΩ	0100332	A
R904	3.3kΩ	0100332	A
R905	82kΩ	0100823	A
R906	10Ω	0100100	A
R907	10Ω	0101100	B
R908	10Ω	0101100	B
R909	10Ω	0103100	B
R910	10Ω	0103100	B
R920	5.6kΩ ±5% ¼W CR.	0107562	A
C901	47µF 6.3 V BPEC.	0530470	A
C902	1µF 50 V EC.	0515109	A
C903	220µF 6.3 V EC.	0510221	A
C904	100µF 50 V EC.	0515101	A
C905	1µF 50 V BPEC.	0535109	A
C906	0.1µF	0601108	B
C907	0.1µF ±10% 50 V MC.	0601108	B
TR901	2SC634A (7, 8)	0305892, 3	A
TR902		0305892, 3	A
D901	1N34A	0310402	A
D902		0310402	A
D903		0310402	A
D904		0310402	A
D905	F-14A	0310940	A
D906		0310940	A
L901	2.5µH Inductor	4290210	B
L902		4290210	B
RY901	Relay	1150101	B
	F-1440 Printed Circuit Board	2598110	

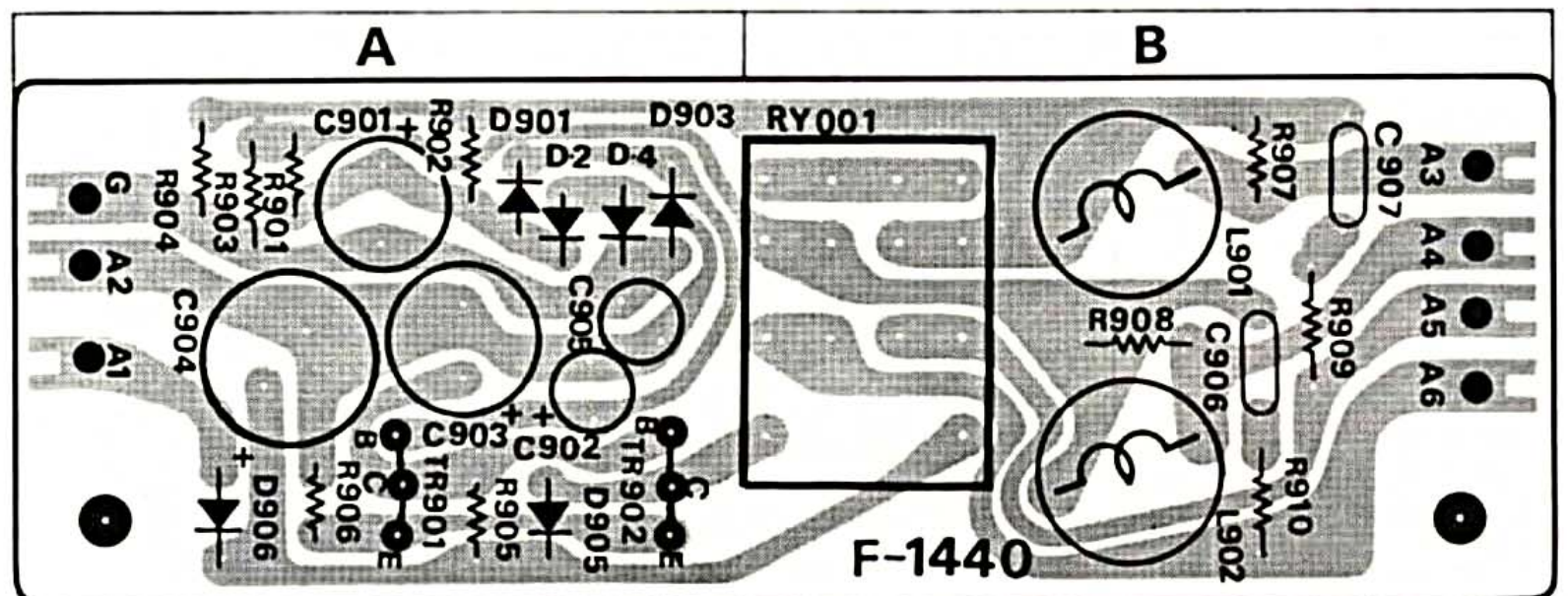

# PRINTED CIRCUIT BOARDS AND PARTS LIST

W: Parts No. X: Parts Name Y: Stock No. Z: Position of Parts

## POWER SUPPLY BLOCK <F-1441>

Stock No. 7500670

W	X	Y	Z	
R003	330Ω } ±10% 3W CrR.	0183331	1, 2 B	
R004		0183391	1, 2 B	
R005	47Ω } ±10% 1W CR.	0104470	2 B	
R006		0104470	2 B	
R007	4.7kΩ	0100472	1 B	
R008	2.2kΩ	0100222	1 B	
R009	1.5kΩ	0100152	1 B	
R010	1.5kΩ	0100152	1 A	
R011	1.5kΩ } ±10% 1/4W CR.	0100152	2 A, B	
R012		47Ω	0100470	2 B
R013		47Ω	0100470	1 A
R014		100Ω	0100101	1 A
R015		100Ω	0100101	1 A
R016	100Ω	0100101	2 A	
C005	220μF } 25 V EC.	0513221	1 B	
C006		0513221	1 B	
C007	100μF	0513101	1 B	
C008	220μF	0515221	1 A, B	
C009	220μF } 50 V EC.	0515221	1 A, B	
C010		0515221	1 B	
C011	220μF	0515221	2 B	
C012	1000μF } 6.3 V EC.	0510102	1 A	
C013		0510102	1 A	

W	X	Y	Z	
C014	1000μF } 6.3 V EC.	0510102	1 A	
C015		0510102	1 A	
C016	220μF } 75 V EC.	0519302	1, 2 A	
C017		0519301	1 A	
C018	470μF	0511471	1 A	
C019	0.047μF } +80% -20% 50 V CC.	0657473	2 B	
C020		0657473	1 B	
TR001	2SD330 (E)	0308362	1 B	
TR002		0308362	1 B	
TR003		0303251, 2	1 A, B	
D002	F-14A	0310940	2 B	
D003		0310940	2 B	
D004		0310940	2 B	
D005		0310940	2 B	
D006		0310940	2 A	
D007		0310940	2 A	
D008		0310940	1 A	
D009		0310940	1 A	
D010		0310940	2 A	
D011		RD-13A (N)	0315310	1 B
D012		RD-24A (M)	0315410	1 B
		F-1441 Printed Circuit Board	2500550	

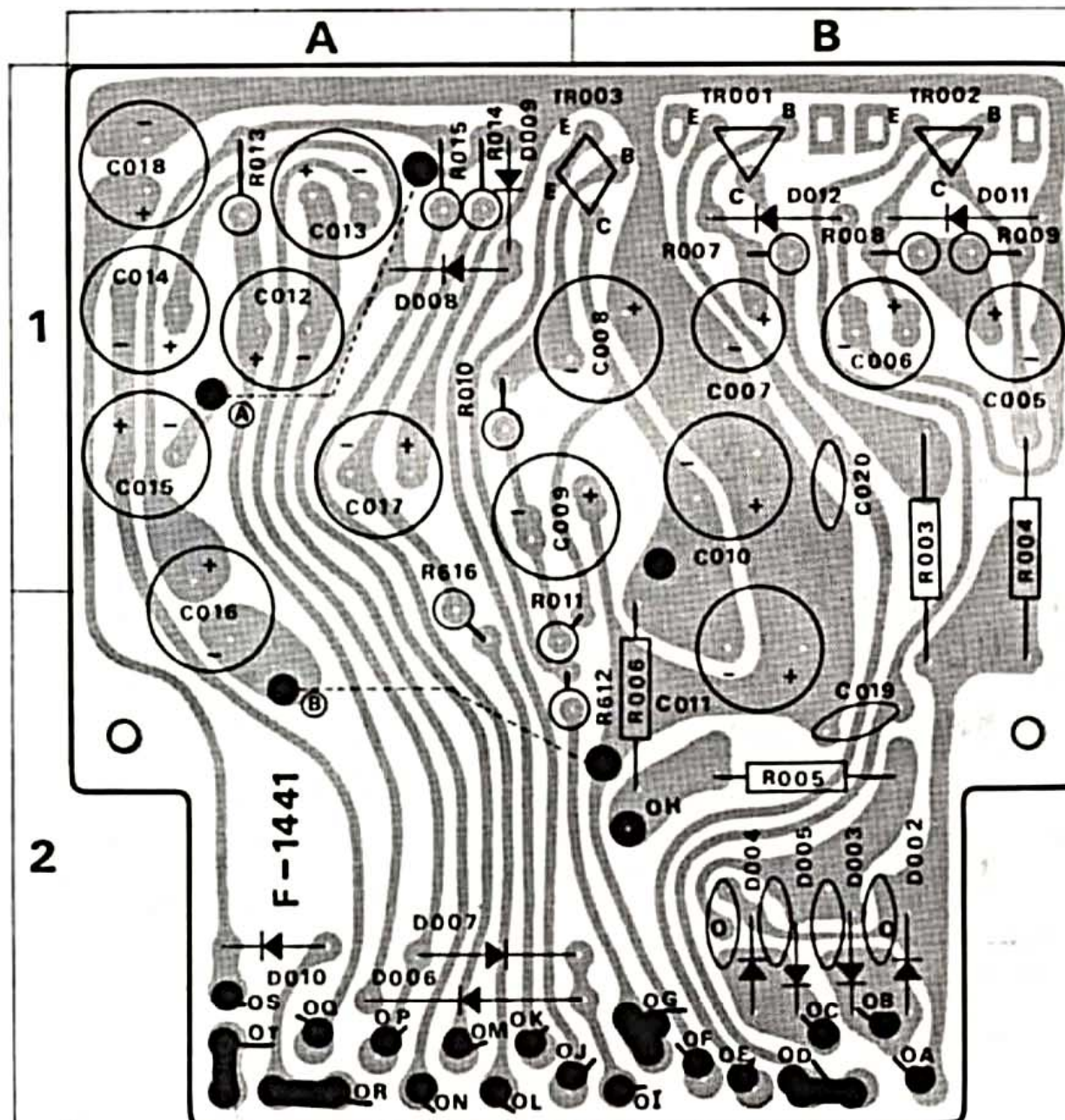

# OTHER PARTS AND THEIR LOCATION ON CHASSIS

## OTHER PARTS

W	X	Y	W	X	Y
R001	3.3k $\Omega$ } $\pm 10\%$ 1W MFR.	0171332	R7044	3.3k $\Omega$ }	0100332
R002	3.3k $\Omega$ }	0171332	R7045	4.7k $\Omega$ }	0100472
R017	22 $\Omega$ } $\pm 10\%$ 1/4W CR.	0101220	R7046	4.7k $\Omega$ }	0100472
R018	560 $\Omega$ } $\pm 10\%$ 1W MFR.	0171561	R7047	5.6k $\Omega$ }	0100562
R019	560 $\Omega$ }	0171561	R7048	5.6k $\Omega$ }	0100562
R020	22 $\Omega$ } $\pm 10\%$ 1/2W SR.	0101472	R7049	5.6k $\Omega$ }	0100562
R021	100k $\Omega$ }	0101104	R7050	5.6k $\Omega$ }	0100562
R022	100k $\Omega$ }	0101104	R7051	5.6k $\Omega$ }	0100562
R023	330k $\Omega$ } $\pm 10\%$ 1/4W CR.	0101334	R7052	5.6k $\Omega$ }	0100562
R024	330k $\Omega$ }	0101334	R7053	5.6k $\Omega$ }	0100562
R025	47 $\Omega$ }	0101470	R7054	5.6k $\Omega$ }	0100562
R026	1k $\Omega$ } $\pm 5\%$ 1/4W CR.	0107102	R7055	3.9k $\Omega$ }	0100392
R7001	1.5k $\Omega$ }	0100152	R7056	3.9k $\Omega$ }	0100392
R7002	1.5k $\Omega$ }	0100152	R7057	3.9k $\Omega$ }	0100392
R7003	2.2k $\Omega$ }	0100222	R7058	3.9k $\Omega$ }	0100392
R7004	2.2k $\Omega$ }	0100222	R7059	2.7k $\Omega$ }	0100272
R7005	2.7k $\Omega$ }	0100272	R7060	2.7k $\Omega$ }	0100272
R7006	2.7k $\Omega$ }	0100272	R861	0.47 $\Omega$ }	0153478
R7007	4.7k $\Omega$ }	0100472	R862	0.47 $\Omega$ }	0153478
R7008	4.7k $\Omega$ }	0100472	R863	0.47 $\Omega$ }	0153478
R7009	6.8k $\Omega$ }	0100682	R864	0.47 $\Omega$ }	0153478
R7010	6.8k $\Omega$ }	0100682	VR701,702	250k $\Omega$ (MN) Balance Control	1010830, 1
R7011	6.8k $\Omega$ }	0100682	VR703,704	250k $\Omega$ (B) $\times$ 2 Volume Control	1010820, 1
R7012	6.8k $\Omega$ }	0100682	C001	4700 $\mu$ F }	0559319
R7013	4.7k $\Omega$ }	0100472	C002	4700 $\mu$ F }	0559319
R7014	4.7k $\Omega$ }	0100472	C003	1000 $\mu$ F }	0559320
R7015	3.3k $\Omega$ }	0100332	C004	1000 $\mu$ F }	0559320
R7016	3.3k $\Omega$ }	0100332	C026	0.0047 $\mu$ F } $\pm 80\%$ 150V CC.	0659802
R7017	2.2k $\Omega$ }	0100222	C027	0.047 $\mu$ F } $\pm 80\%$ 50 V CC.	0657473
R7018	2.2k $\Omega$ }	0100222	C028	0.047 $\mu$ F } $\pm 80\%$ 50 V CC.	0657473
R7019	1k $\Omega$ }	0100102	C029	0.0047 $\mu$ F } $\pm 80\%$ 150V CC.	0659802
R7020	1k $\Omega$ }	0100102	C030	0.033 $\mu$ F } $\pm 20\%$ 250V MPC.	0605337
R7021	2.7k $\Omega$ }	0100272	C031	0.047 $\mu$ F } $\pm 80\%$ 50 V CC.	0657473
R7022	2.7k $\Omega$ }	0100272	C032-035	0.047 $\mu$ F $\times$ 4 50 V CC.	0800121
R7023	3.3k $\Omega$ } $\pm 10\%$ 1/4W CR.	0100332	C038	0.022 $\mu$ F } $\pm 80\%$ 50 V CC.	0657223
R7024	3.3k $\Omega$ }	0100332	C039	0.022 $\mu$ F } $\pm 80\%$ 50 V CC.	0657223
R7025	3.3k $\Omega$ }	0100332	TR810	25C793 (R, Y)	0305450, 1
R7026	3.3k $\Omega$ }	0100332	TR811		0305450, 1
R7027	4.7k $\Omega$ }	0100472	TR812		0300350, 1
R7028	4.7k $\Omega$ }	0100472	TR813		0300350, 1
R7029	4.7k $\Omega$ }	0100472		Power Transistor Socket ( $\times$ 4)	2030020
R7030	4.7k $\Omega$ }	0100472	D001	5B2	0310660
R7031	4.7k $\Omega$ }	0100472	CF207	SFA-10.7MC	0910100
R7032	4.7k $\Omega$ }	0400472	S1	Selector Switch Y-4-11-5	1104320
R7033	4.7k $\Omega$ }	0100472	S10	Speakers Switch Y-2-2-6	1102410
R7034	4.7k $\Omega$ }	0100472	S11	Bass Switch F-2-2-11	1102210, 1
R7035	3.9k $\Omega$ }	0100392	S12	Midrange Switch F-2-2-11	1102210, 1
R7036	3.9k $\Omega$ }	0100392	S13	Treble Switch F-2-2-11	1102210, 1
R7037	3.3k $\Omega$ }	0100332	S14	Power Switch	1130350
R7038	3.3k $\Omega$ }	0100332	PT001	Power Transformer	4001121
R7039	2.7k $\Omega$ }	0100272	L004	AM Bar Antenna	4200540
R7040	2.7k $\Omega$ }	0100272	L005	3.5 $\mu$ H Peaking Coil	4290011
R7041	2.7k $\Omega$ }	0100272	L101	FM Balloon	4290021
R7042	2.7k $\Omega$ }	0100272			
R7043	3.3k $\Omega$ }	0100332			

# OTHER PARTS AND THEIR LOCATION ON CHASSIS

W: Parts No. X: Parts Name Y: Stock No.

W	X	Y
L701	} Choke Transformer	4010090
L702		4010090
M001	±100 $\mu$ A Tuning Meter	4300320
M002	200 $\mu$ A Signal Meter	4300310
J001	DIN Socket	2430040
J002	Tape Rec-2 Jack	2430060
J003	Tape Mon-2 Jack	2430060
J004	Headphones Jack	2430070
PU001	Voltage Selector Socket	2410080
	Voltage Selector Plug	2410090
CO001,002	AC Outlet (×2)	2450040
F001	5A Power Fuse (100/117V)	0431280
	3A Power Fuse (220/240V)	0431260
	Power Fuse Holder	2300020
F801~804	4A Quick Acting Fuse (×4)	0433270
	Quick Acting Fuse Holder	
F01	} Wired in Fuse	0432900
F02		0432830
F05		0432850
F06		0432850
PL001	7V 0.16A PHONO-2 Indicator	0400154
PL002	7V 0.16A PHONO-1 Indicator	0400155

W	X	Y
PL003	7V 0.16A FM Indicator	0400154
PL004	7V 0.16A AM Indicator	0400155
PL005	7V 0.16A AUX Indicator	0400153
PL011	7V 0.16A Power Indicator	0400170
PL012	7V 0.3A F-Type Signal Meter Lamp	0420040
PL013	7V 0.3A F-Type Tuning Meter Lamp	0420040
PL014	6.3V 0.075A Dial Pointer Lamp	0400220
PL015	6V 0.1A FM Stereo Indicator	0400161
	AC Power Supply Cord	3800021
	FM Frontend PA4313U06	2510060
	FM IF Unit F-1450A	7520540
	MPX Unit F-1387B	7540670
	AM IF Unit F-1417B	7530230
	Equalizer Unit F-1435	7550410
	Multi-Connector	2420030
	Tone Unit F-1436	7560560
	Accessory Unit (A) F-1437	7591170
	Accessory Unit (B) F-1438	7591180
	Driver Unit F-1439 (×2)	7570660
	Multi-Connector (×2)	2420040
	Protector Unit F-1440	7598110
	Power Unit F-1441	7500670
	Lamp Holder Unit F-1205	2590520
	Protector Fuse Unit For Power Transformer F-1456	2598120

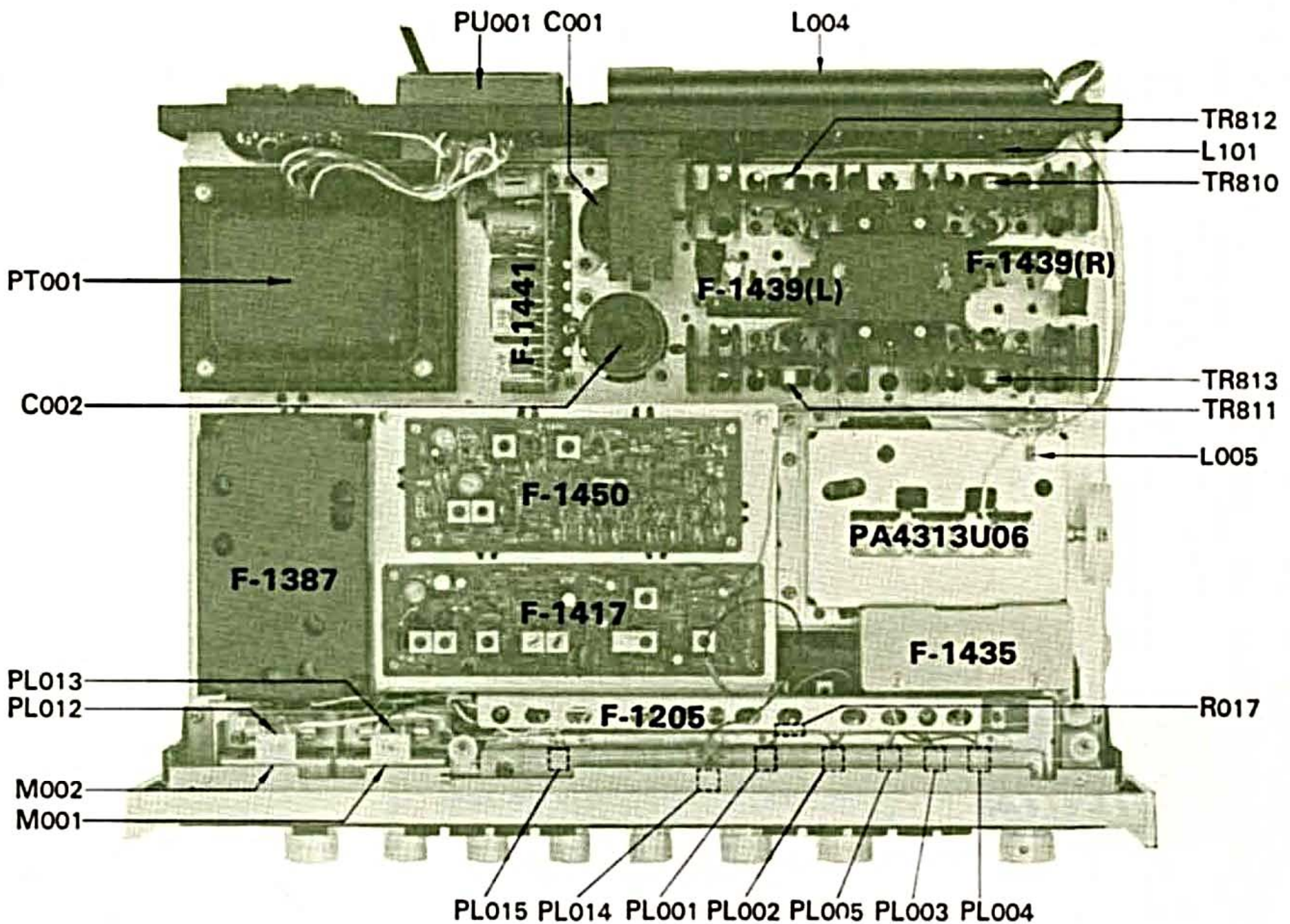
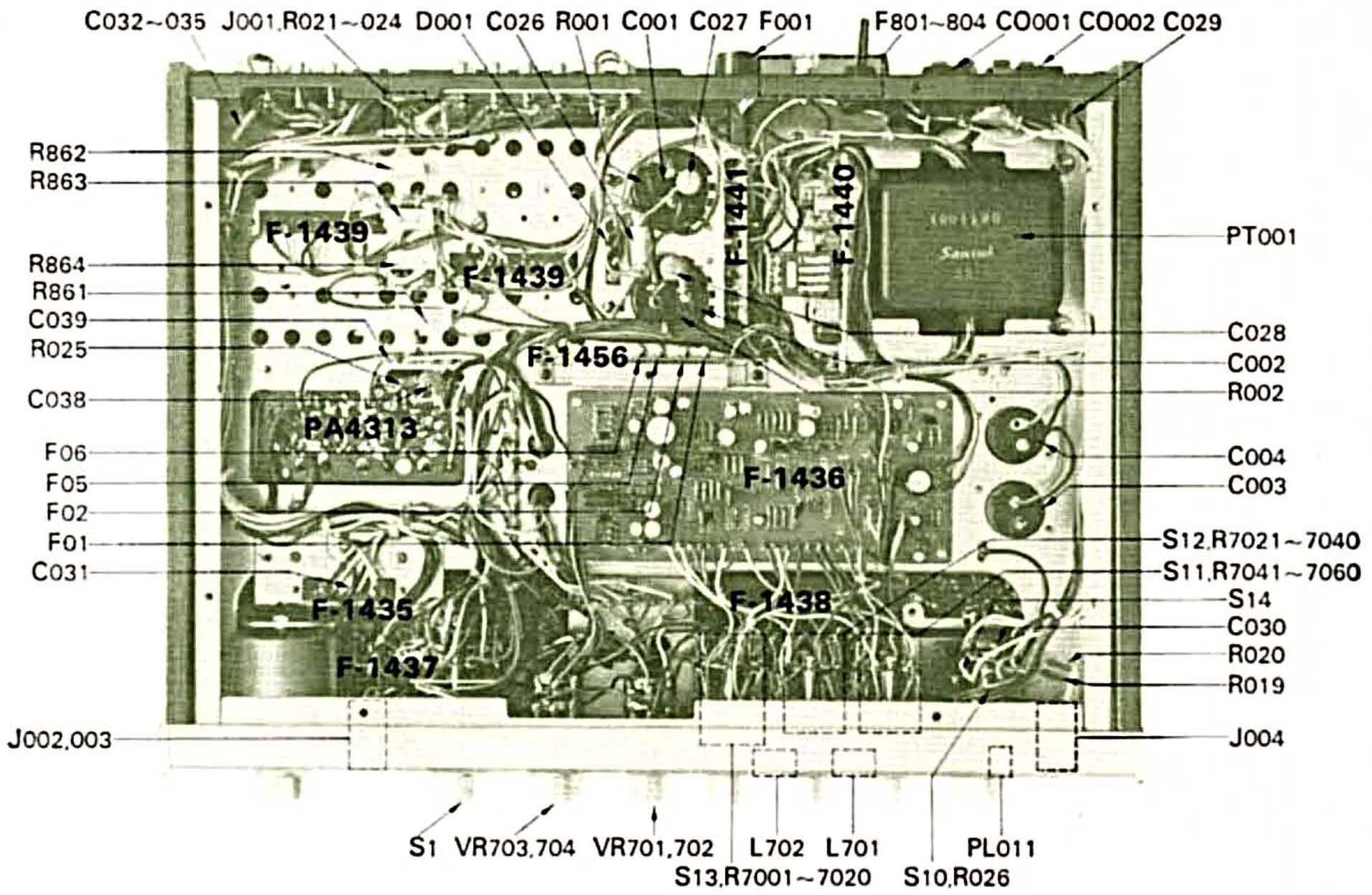



**SANSUI ELECTRIC CO., LTD.**  
14-1, 2-chome, Izumi, Suginami-ku, Tokyo 168, Japan.  
TELEPHONE: (03) 323-1111/TELEX: 232-2076

---

Stock No. 9207090

Printed in Japan (43640M5)